

# NRA<sup>®</sup>

# SMALLBORE RIFLE RULES

Official Rules and Regulations  
to govern the conduct of all  
Conventional and Metric Smallbore Rifle  
Competitions



**NATIONAL RIFLE ASSOCIATION  
OF AMERICA**

11250 Waples Mill Road  
Fairfax, Virginia 22030  
<http://competitions.nra.org/>

REVISED JANUARY 2020\*

NOT OFFICIAL  
WITHOUT THIS SEAL



**OFFICIAL  
COMPETITION**

# SAFETY IS YOUR BUSINESS! READ THE RULES

These rules provide for the efficient and orderly operation of a tournament. But **that's not all**. Many local range regulations exist for one reason alone SAFETY. Others serve a dual purpose, smooth range operation and SAFETY.

It's your responsibility as a competitor or as a tournament official to be familiar with the rules and to know the meaning behind those which are safety oriented.

## NRA GUN SAFETY RULES

### The fundamental NRA rules for safe gun handling are:

- Always keep the gun pointed in a safe direction.
- Always keep your finger off the trigger until ready to shoot.
- Always keep the gun unloaded until ready to use.

### When using or storing a gun, always follow these NRA rules:

- Be sure the gun is safe to operate.
- Know how to safely use the gun.
- Use only the correct ammunition for your gun.
- Know your target and what is beyond.
- Wear eye and ear protection as appropriate.
- Never use alcohol or drugs before or while shooting.
- Store guns so they are not accessible to unauthorized persons.

Be aware that certain types of guns and many shooting activities require additional safety precautions.

To learn more about gun safety, enroll in an NRA safety training or basic marksmanship course, NRA hunter clinic or state hunter education class.

### Shooters Read:

Actions Open . . . . .	10.1.1
Rifles Unloaded . . . . .	10.1.2
Loaded Rifles . . . . .	10.1.3
Cease Firing . . . . .	10.1.4 and 18.10

### Range Operators Read:

Sec. 9 . . . . .	Competition Regulations and Range Operations
Sec. 10 . . . . .	Range Control
Sec. 11 . . . . .	Tournament Officials

\* **Cover Page Note:** It was found that the 60 year old age requirement for the Senior Category in Rule 2.2.1 was accidentally changed to 65 during the publishing file conversion process. This was corrected and the Rule Book was reposted on February 9, 2021. No other changes were made.

# CONTENTS

## NRA SMALLBORE RIFLE RULES

	Page
Approved and Registered Tournaments . . . . .	v
Sec. 1. NRA Competition . . . . .	vi
Sec. 2. Eligibility of Competitors . . . . .	3
Sec. 3. Equipment and Ammunition . . . . .	7
Sec. 4. Targets . . . . .	10
Sec. 5. Positions . . . . .	13
Sec. 6. Range Standards . . . . .	14
Sec. 7. Courses of Fire . . . . .	16
Sec. 8. Time Limits . . . . .	19
Sec. 9. Competition Regulations . . . . .	20
Sec. 10. Range Commands, Control, and Operations . . . . .	24
Sec. 11. Tournament Officials . . . . .	32
Sec. 12. Team Officers' Duties and Position . . . . .	36
Sec. 13. Physically Disabled Shooters . . . . .	37
Sec. 14. Scoring . . . . .	38
Sec. 15. Decision of Ties . . . . .	42
Sec. 16. Challenges and Protests . . . . .	44
Sec. 17. National Records . . . . .	46
Sec. 18. Competitors' Duties and Responsibilities . . . . .	51
Sec. 19. National Smallbore Rifle Classification . . . . .	53
Sec. 20. NRA Official Referee . . . . .	58
Sec. 21. NRA Competition Programs . . . . .	61
Sec. 22. Light Rifle Rules . . . . .	62
Sec. 23. F-Class Smallbore Rifle Rules . . . . .	65
Appendix General Regulations for NRA Sanctioned Tournaments . . . . .	70
Glossary . . . . .	73
NRA Distinguished Smallbore Rifleman Awards . . . . .	75
NRA Honorary Clubs . . . . .	76
Awards Schedules . . . . .	77
Index . . . . .	78
Smallbore Rifle Prone 30° Angle . . . . .	Inside Back Cover

## NOTES

## APPROVED AND REGISTERED TOURNAMENTS

Application forms for both types of Sanctioned Tournaments may be obtained from the NRA. Official application for approval to conduct an NRA Approved or Registered Tournament must be made to the Competitive Shooting Division. The deadline, in advance of firing date, for the receipt of the completed application forms and programs, is 30 days for Approved and 45 days for Registered Tournaments. See General Regulations for *Shooting Sports USA* deadlines.

A Registered Tournament is the more formal of the 2 types. Differences between the 2 types of competitive tournaments are:

	Approved	Registered	Rule
Scores used for classification	Yes	Yes	19.4
Scores used for National Records	No	Yes	17.5
NRA registration fee per competitor (remitted after the tournament is fired). This is explained in sponsor's packet	Yes	Yes	Gen'l Reg. A7, B7
Competitors must be NRA members.	No	No	1.6(d)
Minimum number of shots required	No	Yes	Gen'l Reg. A6, B6
NRA classification or category system must be used	Optional	Yes	Gen'l Reg. A5, B5

**NRA ID Number** is required for classification purposes in all NRA Sanctioned Tournaments. Should a competitor not be an NRA member, he will be assigned a special number which allows his scores to be entered into the computer.

Fixed award schedule	No	Yes	Gen'l Reg. A6, B6
Tournament Officials competing	Yes	Yes	Gen'l Reg. A8, B8
Official Referee may be assigned by NRA	No	Yes, with exceptions	Gen'l Reg B9
Sponsor required to furnish each competitor with Official Bulletin	No	Yes	Gen'l Reg. B12
Program prepared and distributed by Sponsor	Yes	Yes	Gen'l Reg. A1, B1

# NATIONAL RIFLE ASSOCIATION

## Official Rules for Smallbore Rifle Matches

These rules establish uniform standards for NRA Sanctioned Smallbore Rifle competition. Where alternatives are shown, the least restrictive conditions apply unless the tournament program sets forth limitations. The rules do not apply to International Shooting Union type competition. They supersede earlier editions and remain in effect until specifically superseded.

Tournament sponsors may not alter these rules. If sponsors require additional rules for special conditions, the additions must be fully set forth in the program for the competition concerned.

The arrangement and rule numbering systems are such that corresponding rules for other types of NRA competition are correspondingly located and numbered in the Rule Books for those competitions. Gaps in the sequence of rule numbers result from there being a rule in one or more of the other Rule Books which does not apply in this book.

Recommendations for rule changes may be forwarded to the NRA Smallbore Rifle Committee in care of the National Rifle Association.

*Note: Rules in which major changes have been made since publication of the previous Rule Book are marked thus: • (1.1). Rule updates are posted on our website at: [http://rulebooks.nra.org/documents/pdf/compete/rules/rul\\_sbr\\_15.pdf](http://rulebooks.nra.org/documents/pdf/compete/rules/rul_sbr_15.pdf)*

Rules in which major changes have been made are as follows: 9.25, 14.10, 18.15.

## 1. NRA COMPETITION

**1.0 NRA Competition** - NRA Competition is a competition which is authorized in advance of firing by the National Rifle Association. The program, range facilities and officials must comply with standards established by the NRA. The types of tournaments which are Sanctioned are listed in Rule 1.6.

**1.1 Sanctioned Tournaments** - A Sanctioned Tournament is a series of matches covered by an Official Program. Such matches may be all individual matches, all team matches, or a combination of both. They may be all fired matches or a combination of fired and aggregate matches. A tournament may be conducted on one day, or successive days, or may provide for intervening days between portions of the tournament, such as tournaments programmed to be conducted over more than one weekend.

**1.2 Authorization** - Before being publicized in programs or otherwise, the sponsoring organization of each type of competition mentioned in Rule 1.6 shall have agreed to comply with the current regulations for such competition and shall have received notice from the NRA that the competition applied for has been authorized.

**1.3 Rules** - The local sponsor of each type of competition must agree to conduct the authorized competition according to NRA Rules, except as these rules have been modified by the NRA in the General Regulations for that type of competition.

**1.4 General Regulations** - The local sponsor of each type of competition must agree to comply with the General Regulations published by the NRA for the competition concerned. See the Appendix in the back of this rule book.

**1.5 Refusal or Withdrawal of NRA Authorization** - The NRA may refuse to authorize or may withdraw its authorization for any competition which cannot, or does not, comply with the requirements for that competition.

**1.6 Types of Tournaments** - The types of tournaments listed below are those which are Sanctioned by NRA in its competitive shooting program.

- (a) *International Matches* - Arranged by the NRA with the recognized national shooting organization(s) of the countries concerned. The officials thereof are appointed by the NRA (Pershing-Roberts teams).
- (b) *International Team Tryouts* - U.S. tournaments conducted under NRA Rules organized or authorized by the NRA as preliminary or final tryouts for the selection of International Team members. The officials thereof are appointed by the NRA.
- (c) *National Championships* - Organized by the NRA, and in some cases in conjunction with the Civilian Marksmanship Program (CMP), to form the National Matches. The officials thereof are appointed by the NRA, in some circumstances in cooperation with the CMP. These tournaments are Registered.
- (d) *Regional and Sectional Championships* - Arranged between the NRA and a local sponsoring organization. These tournaments are Registered.
- (e) *State Championships* - Annual tournaments authorized and/or conducted by State Rifle and/or Pistol Associations, affiliated with the NRA. Such State Associations may, if desired, authorize local organizations to sponsor and conduct State Championships. In states where there is no NRA affiliated State Association, the NRA may authorize a local organization to sponsor and conduct the State Championship. State Championships are Registered Tournaments.
- (f) *Registered Tournaments* - May be authorized by the NRA after application has been filed by the local organization which will act as the Sponsor. Application forms are available from NRA on request. National Records may be established only in Registered Tournaments (Rule 17.1).
- (g) *Approved Tournaments* - May be authorized by the NRA after application has been filed by the local organization which will act as the Sponsor. Application forms are available from NRA on request. Match Sponsors may require all competitors to be NRA members if specified in the program.
- (h) *Sanctioned Leagues* - (shoulder-to-shoulder or postal) - May be authorized by the NRA after an application has been filed by a local organization. Application forms are available from NRA on request. Sanctioned League scores are used for classification. A League need not be operated by an Affiliated Club or Organization.
- (i) *Postal Matches* - Organized by the NRA and publicized to groups concerned through the *Shooting Sports USA*, announcements and/or special mailings. A Postal Match or home range match is a competition in which entrants fire separately on their home ranges and exchange scores or submit their scores and targets to NRA Headquarters where scores

are evaluated and ranked. The firing of Postal Match scores must be witnessed.

- (j) *Special Tournaments* - May be sanctioned by NRA for types of shooting not otherwise a part of the NRA program.
- (k) *State and Senior Games* - Tournaments which are part of the State and Senior Game program. Such tournaments are not charged fees, nor will any scores fired be used for classification. A simplified sanctioning procedure may be used, and they will be listed in Coming Events of *Shooting Sports USA*, with the only contact being the State Coordinator.

## 1.7 Types of Matches

- (a) *Match* - A complete event as indicated in the program for the awarding of certain specific prizes. A match may consist of one or several stages. It may, in some cases of aggregate matches, include scores in several subsidiary matches.
- (b) *Stage* - A portion of a match which consists of one or more strings fired in one position, distance, time allowance, or target.
- (c) *Open Match* - A match open to anyone, except that if so stated in the program. An open match may be limited to one or any combination of the following. (a) United States citizen; (b) members of the National Rifle Association of America.
- (d) *Restricted Match* - A match in which competition is limited to specified groups, i.e., Juniors, Women, Police, Civilians, Veterans, etc.; or to specified classes, i.e., Masters, Experts, Sharpshooters, Marksmen, etc.
- (e) *Classified Match* - A match in which awards are given to winners and to the highest competitors in several specified classes such as Masters, Experts, Sharpshooters, Marksmen. The classification of competitors may be accomplished by the National Classification System (Sec. 19) or by other means. The program for classified matches must specify the groups or classes in which the awards will be made.
- (f) *Invitational Match* - A match in which participation is limited to those who have been invited to compete.
- (g) *Squadded Individual Match* - A match in which each competitor is assigned a definite relay and target by the Statistical Office. Failure to report on the proper relay or firing point forfeits the right to fire. All entries must be made before firing commences in that match, except when otherwise stated in the tournament program.
- (h) *Unsquadded Individual Match* - A match in which the competitor is not assigned a definite relay or target by the Statistical Office. The competitor reports to the Range Officer within the time limits specified in the program and is then assigned to a target and a relay in which to fire.
- (i) *Re-Entry Match* - A match in which the competitor is permitted to fire more than one score for record; one or more of the highest scores being considered to decide the relative rank of competitors must be specified in the program. Scores fired in these matches shall not be used for classification purposes.
- (j) *Squadded Team Match* - A match in which the teams are assigned a definite time to fire. Teams may be assigned one or



more adjacent targets. All entries must be made before firing commences in that match. The entire team must report and fire as a unit.

- (k) *Unsquadded Team Match* - A match in which the teams may report to the firing line at any time within the limits specified in the program, targets being assigned by the Range Officer. The entire team must report and fire as a unit, unless the program provides otherwise.
- (l) *Aggregate Match* - An aggregate of the scores from two or more matches. This may be an aggregate of match stages, individual matches, team matches, or any combination, provided the tournament program clearly states the matches which will comprise the aggregate. Entries in aggregate matches must be made before the competitor commences firing in any of the matches making up the aggregate match.

## PUBLIC AFFAIRS

All tournament sponsors are urged to give special consideration to the needs of news media personnel in order to achieve maximum publicity for the competition. Public news media personnel representing print and/or broadcast should be given every consideration and cooperation in keeping with the proper conduct of the competition.

## 2. ELIGIBILITY OF COMPETITORS

**Eligibility of Competitors** - *The conditions of a match shall prescribe the eligibility of competitors, team or individuals, in accordance with Rule 1.6 and/or the definitions contained in Section 2. Any limitation of eligibility to compete must be stated in the match program.*

### INDIVIDUALS

**2.1 Members of the National Rifle Association** - Any individual member including Benefactors and Patrons, Endowment, Life, Annual, Associate, Non-Resident and Junior members.

**2.1.1 Non-U.S. Citizen** - Non-U.S. citizens may compete in any NRA Sanctioned Tournament, unless further restrictions are imposed by conditions stated in the program.

**2.2 Civilian** - Any civilian including all members of the Reserve Officer Training Corps (ROTC, NROTC, and AFROTC), personnel of the State Security Forces (e.g., State Guard organizations having no federal recognition), retired members of each of the several services comprising the Armed Forces of the United States, and members and former members entitled to receive pay, retirement pay, retainer pay or equivalent pay, are classified as civilians except as noted in the example below. All competitors who are enrolled undergraduates of any of the service academies will be considered as civilians and may compete in collegiate and ROTC categories.

Individuals of any Reserve or National Guard component who, during the present calendar year, have not competed as National Guard (2.5) or Regular Service (2.6) or Reserve component (2.7) and have not been provided Service support for competition (in the form of firearms, ammunition, payment of travel or other expenses), wholly or in part, may fire as civilians. The provision of firearms and ammunition for specific competition (i.e., National Matches), when such is available to both military and civilian competitors, is not considered Service support under this rule.

Unless specifically authorized to do so by the tournament program, members of the regular Army, Navy, Air Force, Marine Corps, Coast Guard; members of the reserve components on active duty; returned personnel of the several services comprising the Armed Forces of the United States on active duty; or police (2.4) are not permitted to compete as civilians.

• **2.2.1 Senior** - A person may compete as a senior provided the person is 60 years old or older on the first day of competition.

**2.3 Junior** - A person may compete as a Junior through December 31 of the calendar year in which his or her 20th birthday occurs. Individuals who have National Guard, Reserve, or active duty status and receive support (as defined in Rule 2.2) may not compete as Juniors.

**2.3.1 Intermediate Junior** - A Junior may also compete as an Intermediate Junior from January 1, of the calendar year in which his or her 15th birthday occurs through December 31 of the calendar year in which his or her 17th birthday occurs.

**2.3.2 Sub-Junior** - A Junior may also compete as a Sub-Junior through December 31, of the calendar year in which his or her 14th birthday occurs.

## **2.4 Police**

- (a) Regular full time law enforcement officers of a regularly constituted law enforcement agency of a municipal, county, state, or federal government. Full-time Police Firearms Instructors in Law Enforcement or Police Academies are eligible to compete in the respective Police category. Official current identification from the agency employing a civilian full-time Police Firearms Instructor will be required.
- (b) Full-time salaried Railroad Police; Penal Institution guards; Industrial Police, including Bank Guards; and Armored and Express Company Guards.
- (c) Officers of a regularly organized Reserve or Auxiliary named in (a) above, provided that when on duty they are required to perform the same law enforcement functions and/or duties as the agency to which they are in reserve and are authorized to be armed by the appointing authority.
- (d) Officers who qualify under sections (a) and (b) may, after retirement and if receiving retirement benefits, enter competition covered by these rules. Such retirees who are employed after retirement in any agency which qualifies for entry in NRA Sanctioned competition as a police agency may not compete as a retired officer, but may compete as a member of the organization in which he is at present serving.
- (e) Military Police - Members of the Armed Forces of the United States, Regular or Reserve Component; private detectives; private bodyguards; honorary police or sheriffs; consultants; or any persons who are members of a body organized for ceremonial purposes may not compete in NRA Sanctioned Tournaments in the Police category regardless of the name given to such a body and regardless of the titles given such members.
- (f) Persons employed as Industrial Police by private industry on a part-time basis, or where such employment is not the sole occupation of such persons, may not compete in NRA Sanctioned Tournaments in the Police category.

**2.4.1 Eligibility Authentication** - It is the competitor's responsibility to have a Police Identification card in his possession when entering and competing in the Police Category in any NRA Sanctioned Tournament.

**2.5 National Guard** - Federally recognized officers or enlisted persons of the Army National Guard, the Air National Guard, or the Naval Militia of the several states, territories, the District of Columbia, or the Commonwealth of Puerto Rico, who are not on extended active duty, are eligible to compete as Juniors and/or Collegiate if otherwise qualified.

**2.6 Regular Service** - Officers or enlisted persons of the Regular United States Army, Navy, Air Force, Marine Corps, Coast Guard, and members of reserve components thereof, who are on extended active duty; provided the term "reserve components shall include Army National Guard and Air National Guard called into federal service and while in such status are eligible to compete as Juniors and/or Collegiate if otherwise qualified.

**2.7 Reserve Components** - Officers and enlisted persons of any reserve components of the Armed Forces, exclusive of the Army National Guard and the Air National guard of the United States, not on extended active duty are eligible to compete as Juniors and/or Collegiate if otherwise qualified.

**2.8 College** - Regularly enrolled undergraduate students who carry 12 or more semester hours or the equivalent in an accredited two or four year collegiate level institution and who have not received a Bachelor's Degree. Eligibility to compete as a collegian shall extend for a maximum of four academic years within a five-year period beginning when a student first attends any class as a full-time (12 or more credit hours) student. The five year period may only be interrupted by extended military service, (60 consecutive days or more) service with a recognized foreign aid agency of the U.S. Government or certified missionary service.

**2.9 School** - Regularly enrolled undergraduate students of any primary or secondary school, who comply with the eligibility rules of their institution.

**2.9.1 Military Scholastic** - is a Junior who is an active member of a high school JROTC unit or enrolled in a military high school.

## TEAMS

**2.10 Team Representation** - No individual may be a Team Captain, Coach, firing member, or alternate firing member on more than one team in any one match.

Note: Entries will not be accepted from Pickup teams (teams whose members are selected without regard to club or other organizational affiliation) unless the program specifically provides for such eligibility. Pick-up teams are not eligible for National Records.

**2.11 Club Teams** - All team members, including team captain and coach, must have been active fully-paid members of the club which the team represents for a period of at least 30 days immediately prior to the competition. The club may be affiliated with NRA. As specifically allowed by conditions of the program, a person who is not a club member may serve as a non-firing coach of such a team. There are two types of teams allowed in this rule:

- (a) *Local Club Teams* - Local Club Teams must be composed of members who reside within the same state, territory or prov-

ince or residents of other states who live within 50 miles of the local club.

Note: The Internet website MapQuest will be used to determine the distance between the local club's NRA address of record and the competitor's NRA address of record.

- (b) *Open Club Teams* - Open Club Teams must be composed of club members all of whom are not necessarily legal residents in the same state, territory or province. (A single club could have more than one team, one of which could be a local Club Team; and another an Open Club Team.)

**2.11.1 Affiliated Other Organization-** All members including team captains and coach of such teams must have been fully-paid members of the organization the team represents or maintained on its roster, for a period of at least 30 days immediately prior to competition and the organization must be affiliated with the NRA in good standing.

**2.12 State Association Teams** - Members of such teams must be bona fide residents of the state represented, and individual members of the State Rifle and/or Pistol Association, if such State Association provides for individual membership, or be members of a rifle and/or pistol club which is affiliated and in good standing with the State Association concerned at the time of the competition. State Association Teams permitted to enter the competitions by the tournament program conditions must be authorized and accredited by the Association for that tournament. Authorization shall be signed by the Association President, Vice President or Secretary. Such State Associations must be affiliated and in good standing with the NRA at the time of the competition. If specifically allowed by conditions of the program, a person, not a State Association member, may serve as the Coach of a State Association team. He may not be a firing member.

*Note: Teams representing State Associations, Leagues and other associations (composed of more than one club) are not club teams. Such teams may enter NRA Sanctioned Matches only when the program specifically authorizes such entry.*

**2.13 Regular Service, National Guard, or Armed Forces Reserve Teams** - Members, including captains and coach, of such teams must have been commissioned or enlisted members of their respective service for a continuous period of at least 30 days immediately preceding the day of the competition. Army National Guard, Air National Guard and Naval Militia personnel may be combined into a single team.

**2.14 Police Teams** - Members of such teams must be from the same agency, regular or reserve, and in active service for a continuous period of at least 30 days immediately preceding the day of competition.

**2.15 Civilian Club Teams** - Firing and alternate members of such teams must comply with Rules 2.2 and 2.11.

**2.16 College Teams** - Firing and alternate members of such teams must comply with Rules 2.8 and 2.11.

**2.17 School Teams** - Firing and alternate members of such teams must comply with Rules 2.9 and 2.11.

**2.17.1 Military Scholastic Team** - Firing and alternate members of such teams must comply with Rule 2.9.1 and 2.1.

**2.18 Junior Club Teams** - Firing and alternate members of such teams must comply with Rules 2.3 and 2.11.

**2.20 Residence** - In those matches which are limited to residents of any specified geographical area, a resident is defined as:

- (a) A person who presents photo identification issued by a government entity, which shows a residential address within the specified geographical area.
- (b) Military Personnel: The place of residence of members of the Military, on active duty is defined as the place at which they are stationed by reason of official orders, provided they have been so stationed within the specified area for a period of at least 30 days immediately prior to the day of the match. In the case of retired, Reserve, or National Guard personnel not on active duty, the provisions of Paragraph (a) will apply. Naval personnel assigned on sea duty qualify for a residence in the area which is the usual base or home port of the unit to which attached.
- (c) Federal and State Law Enforcement Officers: The provisions of paragraph (b) will apply.

### **3. EQUIPMENT AND AMMUNITION**

This section defines authorized equipment. Where alternative types of equipment are shown, the least restrictive conditions apply unless the tournament programs set forth limitations.

**3.1 The Rifle** - The rifle authorized for use in smallbore rifle matches is the .22 caliber rimfire chambered for cartridges commercially catalogued as the .22 Short, .22 Long, or .22 Long Rifle cartridges. There are no restrictions on the barrel length or overall weight of the rifle and accessories. No portion of the rifle or any attachment to the rifle shall extend more than 3 inches beyond the rear of the shooter's shoulder. The trigger pull must be capable of lifting 3 pounds. The same rifle must be used throughout all stages of any one match (except aggregate) except in the case of a malfunction or disabled rifle, when the competitor may change rifles with permission of the Chief Range Officer.

**3.2 Any Rifle** - A rifle authorized for use in smallbore rifle matches using cartridges commercially catalogued as the .22 Short, .22 Long or .22 Long Rifle cartridges. There are no restrictions on the barrel length or overall weight of the rifle and accessories. Any safe trigger is allowed. No portion of the rifle or any attachment to the rifle shall extend more than 3 inches beyond the rear of the shooter's shoulder. A butt plate conforming with NRA Rule 3.15 may be used. Around the body, or around the shoulder hooks are not permitted. The same rifle must be used throughout all stages of any one match (except aggregate) except in the case of a malfunction or disabled rifle when the competitor may change rifles with permission of the Chief Range Officer. In NRA Metric Position Course shooting, this rule will govern the conduct of the match and may not be waived by the Match Sponsor.

**3.3 Light Rifle** - Any .22 caliber rimfire (.22 Short, .22 Long, or .22 Long Rifle) with not less than a 2 pound trigger pull and which weighs not more than 8 ½ pounds when equipped with sights.

**3.4 Junior Rifle** - A rifle authorized for use in Junior competition using cartridges commercially catalogued as a rimfire .22 Short, .22 Long, or .22 Long Rifle cartridge. There shall be no restrictions on the barrel length or overall weight of the rifle. Any safe trigger is allowed. The rifle may not be equipped with thumb hole stock, Schuetzen Type

Butt Plate (Rule 3.15), or palm rest (Rule 3.14). Adult use of this rule in open competition is permitted.

**3.5 Trigger Guard** - A rifle must be equipped with an effective trigger guard. Lack of a trigger guard constitutes an unsafe rifle.

### 3.7 Sights

(a) *Metallic*

(1) Non-corrective: Any sighting system, constructed of metal or equivalent, which provides a method of aiming or aligning 2 separate but visible sights, or reference points mounted on the rifle, including tube sights and non-magnifying color filters.

(2) Corrective: Same as (1), except that a lens or system of lenses, not containing an aiming reference or reticle at the focal plane of any such lens or system of lenses, may be included in such system.

(b) *Telescopic* - Any sighting system which includes a lens or system of lenses and an aiming reference or reticle at the focal plane of a lens or system of lenses.

(c) *Any* - Any sight without restriction as to material or construction.

(d) *Prohibited* - Any sighting device programmed to activate the firing mechanism is prohibited.

**3.8 Spotting Scopes** - The use of a telescope to spot shots is permitted. It may be positioned forward of the shooter's forward shoulder (Rule 9.9).

**3.9 Shooting Kits** - The shooting kit may not be placed forward of the shooter's forward shoulder on the firing line, except that in the standing position a shooting kit, table, or stand may be used as a rifle rest between shots. The shooting kit, table, or stand may not be of such size and construction as to interfere with shooters on adjacent firing points or to constitute a wind break (Rule 9.9).

**3.9.1 Personal Wind Indicators** - Competitors may use personal wind indicating devices, placement of which is not to exceed 24 inches in front of the firing line, as long as they do not interfere with other competitors or range operation. (See Rules 6.9 and 9.9)

**3.10 Ground Cloth** - Ground cloth may be used providing it is not constructed or used in a manner to provide artificial rest or support. *This is not to preclude the use of more than one ground cloth.*

### 3.11 Clothing Regulations - General

**3.11.1 Gloves** - Gloves may be worn which do not form an artificial support.

**3.11.2 Shooting Coats** - Are permitted in all events. They may be constructed of cloth, canvas, nylon, leather or any combination of these materials. They may be lined or unlined. The lining may be smooth or quilted. There may be elbow pads, a shoulder pad and a sling pad made of non-slip material.

**3.11.3 Shooting Trousers** - Are permitted in all events. They may be constructed of cloth, canvas, nylon, leather or any combination of these materials. They may be lined or unlined. The lining may be

smooth or quilted. There may be knee and seat reinforcements that may be made of a non-slip material.

**3.12 Padding** - Shoulder pads, sling pads and elbow pads may be worn while shooting, provided they are constructed so as not to provide artificial support. A button, hook or strap may be placed on the sleeve of the shooting coat to support the sling loop that is placed on the upper arm.

**3.13 Slings** - Unless otherwise specified in the conditions of the match, the rifle sling may be used in connection with the rifle and one arm only as an auxiliary to steady the rifle except in the standing position. Sling cuffs and sling pads are permitted. (See Rules 5.12, 5.13) No part of the sling under tension may touch the rifle stock except at the sling swivel and handstop. (Loose, excess sling material not involved in supporting the rifle may make incidental contact with the stock if not arranged to cause artificial support.)

**3.14 Palm Rest** - A palm rest is an attachment or extension below the forearm which aids the normal hand grip and support of the piece by the forward hand and arm. The use of a palm rest in the standing position is allowed under Rules 3.1 and 3.2.

**3.14.1 Kneeling Roll** - A cylindrical cushion for shooting in the kneeling position; maximum dimensions will be ~9 ¾ inches long (25 cm) and ~7 inches in diameter (18 cm), and made of soft and flexible material.

**3.15 Butt Plates and Hook** - A butt hook projecting not more than 153 mm (~6 inches) past the rear of a line, which is perpendicular to a line drawn through the axis of the bore of the rifle, and which is tangent to the deepest part of the butt plate depression that normally rests against the shoulder. It must have a total outside length around any curve or bend of not more than 178 mm (7 inches).

**3.16 Release Triggers** - Triggers which function on release are prohibited.

**3.17 Ammunition** - Rimfire cartridges commercially catalogued as the .22 Short, .22 Long, or .22 Long Rifle which have an over-all length not more than 1.1 inches and loaded with a lead or alloy bullet of not larger than .23 inch diameter. Hollow point, tracer, incendiary or explosive bullets are specifically excluded from ammunition authorized for match use.

**3.18 General** - All devices or equipment which may facilitate shooting and which are not mentioned in these rules, and which are contrary to the spirit of these rules and regulations, are forbidden. A Tournament Official shall have the right to examine a shooter's equipment or apparel. The responsibility shall be upon the competitor to submit questionable equipment and apparel for official inspection and approval in sufficient time prior to the beginning of a match so that it will not inconvenience either the competitor or the official.

**3.19 Eye Protection** - All competitors and other personnel in the immediate vicinity of the range complex are urged to wear eye protection devices.

**3.20 Ear Protection** - All competitors and other personnel in the immediate vicinity of the range complex are urged to wear hearing protection devices. Only sound reducing devices may be worn by competitors forward of the ready line.

*Competitors should be aware that match sponsors (and/or ranges) may require that all competitors wear eye and ear protection while attending a match on their range.*

**3.21 Empty Chamber Indicator (ECI)** - A smallbore ECI is required in all smallbore rifle competitions to indicate that the chamber is empty. Any substitute indicator may be used as long as it has a probe into the empty chamber, has a flag attached and is a bright color.

**3.22 Audible Timing Devices** - Audible timing devices are allowed.

**3.23 Electronic Devices** - Radios, tape recorders, or any type of sound producing or communications systems are prohibited forward of the ready line except hearing aids and those devices necessary for range control.

## 4. TARGETS

The dimensions given are to the outside edge of the scoring rings.

**4.1 Official Targets** - In NRA Sanctioned competition, only targets printed by NRA Licensed Manufacturers, bearing the Official Competition target seal, or military targets issued by the Armed Services, without modifications except as authorized by NRA will be used. Tar-

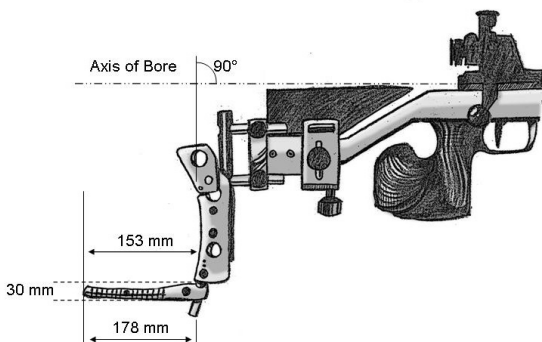

gets will be mounted only vertically on existing range hangers (frames) with the highest numbered bullseye(s) at the bottom. All NRA Official Competition Targets are printed by NRA licensed manufacturers only. They may not be modified by the user or the manufacturer, except with specific written permission from NRA Competitions Division. NRA Target Masters are made using Computer Assisted Design and must be used in production of all NRA Targets.

### OFFICIAL TARGET DIMENSIONS

**4.2 50 Foot Target. A-17** - 11 bullseyes (1 for sighting) for use in Conventional 4-Position competition only. 6 through 10 rings black.

10 ring.....	150 inch	7 ring.....	1.150 inches
9 ring.....	483 inch	6 ring.....	1.483 inches
8 ring.....	817 inch	5 ring.....	1.817 inches

**4.3. 50 Foot Target. NRA/USAS-50** - 12 bullseyes (2 for sighting) 50 meter International Smallbore Rifle Target reduced for firing at 50 feet. 3 through 10 rings black.



10 ring.....	0.76 mm	6 ring.....	18.75 mm
9 ring.....	4.12 mm	5 ring.....	23.63 mm
8 ring.....	9.00 mm	4 ring.....	28.50 mm
7 ring.....	13.87 mm	3 ring.....	33.38 mm

**4.4 50 Foot Light Rifle Target. A-32** - 6 bullseyes (1 for sighting). For use with NRA Light Rifle only. 8 through 10 rings black, with white dot in center of 10 ring.

Aiming dot.....	.218 inch	8 ring.....	1.874 inches
10 ring.....	.439 inch	7 ring.....	2.656 inches
9 ring.....	1.187 inch	6 ring.....	3.374 inches

**4.5 75 Foot Target. A7/5** - 5 bullseyes, and **A7/10**, 10 bullseyes. For use in Conventional 4-Position only. 6 through 10 rings black.

10 ring.....	.335 inch	7 ring.....	1.835 inches
9 ring.....	.835 inch	6 ring.....	2.335 inches
8 ring.....	1.335 inch	5 ring.....	2.835 inches

**4.6 50 Yard Target. A-23/3** - 3 bullseyes, and **A-23/5**, 5 bullseyes, and **A-23/6**, 6 bullseyes. For use in Conventional 4-Position and 50 yard stage of Conventional Prone competitions only. 7 through 10 rings black.

X ring.....	.39 inch	7 ring.....	3.89 inches
10 ring.....	.89 inch	6 ring.....	4.89 inches
9 ring.....	1.89 inches	5 ring.....	5.89 inches
8 ring.....	2.89 inches		

**4.7 50 Yard Target. A-27/5**, 5 bullseyes. **A-27/6**, 6 bullseyes. 50 meter target reduced for firing at 50 yards. For use in Conventional Prone competition only. 3.89 inches diameter black.

X ring.....	.359 inch	7 ring.....	2.879 inches
10 ring.....	.719 inch	6 ring.....	3.599 inches
9 ring.....	1.439 inches	5 ring.....	4.319 inches
8 ring.....	2.159 inches	4 ring.....	5.038 inches

**4.8 50 Yard Target. A-51** - 6 bullseyes. 50 meter ISSF target reduced for firing at 50 yards. For use in NRA Metric Position and Metric Prone competition.

Aiming Black = 102.78 mm (dimensions derived from 50 meter target)

Inner 10 ring.....	4.096 mm	5 ring.....	82.186 mm
10 ring.....	9.034 mm	4 ring.....	96.816 mm
9 ring.....	23.664 mm	3 ring.....	111.447 mm
8 ring.....	38.295 mm	2 ring.....	126.077 mm
7 ring.....	52.925 mm	1 ring.....	140.708 mm
6 ring.....	67.556 mm		

**4.9 50 Meter Target. A-26/5** - 5 bullseyes, and **A-26/6**, 6 bullseyes. For use in Conventional Prone competition only. 4.27 inches diameter black.

X ring.....	.393 inch	7 ring.....	3.148 inches
10 ring.....	.787 inch	6 ring.....	3.936 inches
9 ring.....	1.574 inches	5 ring.....	4.723 inches
8 ring.....	2.361 inches	4 ring.....	5.510 inches

**4.10 50 Meter ISSF Target. A-50** - 6 bullseyes. For use in NRA Metric Position and Metric Prone competition. Aiming Black 112.4 mm.

Inner 10 ring.....	5.0 mm	5 ring.....	90.4 mm
10 ring.....	10.4 mm	4 ring.....	106.4 mm
9 ring.....	26.4 mm	3 ring.....	122.4 mm
8 ring.....	42.4 mm	2 ring.....	138.4 mm
7 ring.....	58.4 mm	1 ring.....	154.4 mm
6 ring.....	74.4 mm		

**4.11 100 Yard Target. A-25** - 3 bullseyes. For use in Conventional Prone competition only. 7 through 10 rings black.

X ring.....	1 inch	7 ring.....	8 inches
10 ring.....	2 inches	6 ring.....	10 inches
9 ring.....	4 inches	5 ring.....	12 inches
8 ring.....	6 inches		

**4.12 100 Yard Target. A-33** - 3 bullseyes. ISSF 300 meter target reduced to 100 yards. For use in Metric Prone competition only. 4 through 10 rings black.

10 ring.....	1.045 inches	5 ring.....	7.045 inches
9 ring.....	2.245 inches	4 ring.....	8.245 inches
8 ring.....	3.445 inches	3 ring.....	9.445 inches
7 ring.....	4.645 inches	2 ring.....	10.645 inches
6 ring.....	5.845 inches	1 ring.....	11.845 inches

**4.13 200 Yard Target. A-21** - Single bullseye. 8, 9, and 10 rings black. (A-21 C Repair Center)

X ring.....	2 inches	8 ring.....	12 inches
10 ring.....	4 inches	7 ring.....	16 inches
9 ring.....	8 inches	6 ring.....	20 inches

**4.14 50 Yard Target. A-31** - 5 bullseyes. For use in NRA Light Rifle only. 7 through 10 rings black.

10 ring.....	1.025 inches	7 ring.....	4.165 inches
9 ring.....	2.21 inches	6 ring.....	5.812 inches
8 ring.....	3.420 inches		

**• 4.15 Mini-palma 100 Yard Targets -**

**100 Yard Target. A-37** - 4 bullseyes. LR (800 yds) target reduced to 100 yards. For use in Prone competition only. 6 through X rings black.

X-ring.....	1.00" inches	7 ring.....	4.90 inches
10 ring.....	2.00" inches	6 ring.....	5.80 inches
9 ring.....	2.90 inches	5 ring.....	6.80 inches
8 ring.....	3.90 inches		

**100 Yard Target. A-38** - 4 bullseyes. LR (900 yds) target reduced to 100 yards. For use in Prone competition only. 6 through X rings black.

X-ring.....	0.90" inches	7 ring.....	4.30 inches
10 ring.....	1.80" inches	6 ring.....	5.10 inches
9 ring.....	2.60 inches	5 ring.....	6.00 inches
8 ring.....	3.40 inches		

**100 Yard Target. A-39** - 4 bullseyes. LR (1000 yds) target reduced to 100 yards. For use in Prone competition only. 6 through X rings black.

X-ring .....	0.80" inches	7 ring .....	3.80 inches
10 ring .....	1.60" inches	6 ring .....	4.60 inches
9 ring .....	2.30 inches	5 ring.....	5.40 inches
8 ring .....	3.10 inches		

## 5. POSITIONS

*Positions - The positions for use in a match shall be stated in the program under conditions of the match and shall be in accord with the definitions of positions prescribed in this section.*

No portion of the shooter's body or body clothing may rest upon or touch the ground in advance of the firing line.

**5.1 The Ground** - All references to the ground in the following position rules are to be construed as applying to the surface of the firing point, floor, such as shooting mats, or platforms as are customarily used on shooting ranges.

**5.2 Artificial Support** - Any supporting surface except the ground not specifically authorized for use in the rules for the position prescribed. Digging or use of elbow or heel holes at the firing points or the use of depressions which form artificial support for the elbows, arms, or legs is prohibited. Use of artificial support including back braces is prohibited except as individually authorized by NRA for a physically handicapped shooter.

**5.3 Position of Rifle Butt** - In all positions, except standing (Rule 5.12), the butt of the rifle must be held against the front of the shoulder on the outside of the shooting coat or shirt and must not touch the ground.



**5.6 Prone** - Body extended on the ground, head toward the target. The rifle will be supported by both hands and one shoulder only. No portion of the arms below the elbows shall rest upon the ground or any artificial support, nor may any portion of the rifle or body rest against any artificial support. The forearm supporting the rifle shall form an angle with the line from the point of elbow contact, to the target of not less than 30°. (Measured through the axis of the forearm.)



**5.8 Sitting** - Weight of the body supported on the buttocks and the feet or ankles, no other portion of the body touching the ground. The rifle will be supported by both hands and one shoulder only. Elbows may rest on the legs at any point above the ankles. (The elbow is defined as 4 inches from the point of the arm when bent.)

**5.10 Kneeling** - Buttocks clear of the ground, but may rest on one foot. The rifle will be supported by both hands and one shoulder only. The elbow of the arm supporting the rifle rests on the knee or leg. The elbow of the trigger arm will be free from all support. One knee must be touching the ground or shooting mat.



The shooter may be on all, partially on, or all off the shooting mat. A roll as described in Rule 3.14.1 may be placed under the instep provided the foot is placed toe down at an angle not greater than 45 degrees from the vertical. Only the trousers and underclothing may be worn between the shooter's buttocks and heel. The jacket or other article may not be placed between these two points. (Elbow is defined in Rule 5.8.) If the kneeling roll is not used, the foot may be positioned at any angle, to include placing the side of the foot and the lower leg in contact with the ground. Competitors 55 years of age and older (beginning January 1 of the calendar year in which they turn 55) may use two kneeling rolls in the kneeling position. The second roll (which must conform to Rule 3.14.1) will be used between the right heel and right buttock (right hand shooter). Reverse procedure for left hand shooters.

**5.12 Standing** - The shooter shall stand free with both feet on the ground or a thin mat without any other support. The rifle shall be held with both hands and the shoulder (upper right chest) or the upper arm near the shoulder, the cheek and the part of the chest next to the right shoulder. However the rifle must not be supported by the jacket or chest beyond the area of the right shoulder and right chest. The left upper arm and elbow may be supported on the chest or on the hip. In the free rifle events, a palm rest may be used in this position. The use of the sling is prohibited for all rifles. (Left handed shooters reverse these descriptions).



**5.13 Any** - Any position in which the rifle is supported only by the body, assisted if desired by the sling, with no artificial support, and by which no competitors or range personnel are endangered. (See Rule 3.13)

**5.14 Illegal** - Anyone found using an illegal position shall be warned once and given an opportunity to correct his position. If the same person continues to use an illegal position or reverts to it, he shall be penalized according to the provision of Rule 9.30.

## 6. RANGE STANDARDS

**6.1 Firing Line** - The firing line is immediately in front of the several firing points. All ranges are measured from this firing line to the face of the targets when targets are hung in their proper position in front of the backstop.

**6.2 Firing Point** - That part of the range provided for the competitor immediately in the rear of the firing line from which firing takes place. Each firing point is numbered to correspond with the target frames. Each firing point should have a minimum width of five feet (except in gallery ranges where a minimum of four feet is permissible).

**6.3 Shelter** - Prone, Outdoor 4-Position and 3-Position. The firing points of outdoor ranges may be covered and enclosed on 3 sides, open toward the targets. There must be ample room for Range Officers and witnesses to move freely to the rear of the shooter. This does not preclude the construction of ranges within areas surrounded or partially surrounded by safety walls.

*Firing line shelters are solely the responsibility of the match sponsor.*

### 6.4 Distance

- (a) Indoor rifle ranges are 50 feet or 75 feet.
- (b) Outdoor rifle ranges may be 50 yards, 50 meters, 100 yards or any combination thereof.

*Indoor distances may be used outdoors and outdoor distances used indoors.*

**6.5 Illumination** - Artificial illumination of ranges is authorized. Artificial illumination for indoor ranges should provide the necessary level of even light without glare or distracting shadows on the target or firing positions. The background area behind the targets should be of non-glaring light color. Outdoor Sanctioned Leagues or Approved Tournaments may be fired under artificial illumination.

**6.6 Target Numbers** - Target frames will be numbered on alternating background of contrasting color. The number will be large enough to be identified under ordinary conditions with normal vision. The numbers should be at least nine inches high and must correspond with firing point numbers.

**6.7 Backing Targets** - are to be used to identify cross-fires and multiple shot holes.

- (a) At 50 feet and 75 feet tagboard backing targets must be used in Registered Tournaments. Backing targets may be used at sponsors discretion in Approved Tournaments. Distance between record target and backing target will be 3 inches.
- (b) Tagboard backing targets will be used at all mid-ranges in Registered or Approved Tournaments. Target frames should be the same distance center to center as the firing points and should be carefully constructed to assure uniform spacing between record and backing targets.

Distance between record target and backing target should be as indicated in following table to give ¼ inch offset in the location of the bullet holes in the target and backing cards:

<i>Distance Between Firing Points</i>	<i>100 Yards</i>	<i>50 Yards</i>	<i>50 Meters</i>
5 Ft – 0 In	15"	7 ½"	8 ½"
5 Ft – 6 In	13 ¾"	7 ½"	
6 Ft – 0 In	12 ½"	6 ¼"	6"

*Each range should establish a cross-fire gauge for their range.*

**6.8 Target Height** - Suggested target heights for an indoor multi-bull target should be approximately 14" to the center of the bottom bulls in the Prone position, 26" to the center of the bottom bulls in the Sitting and Kneeling positions, and up to 55" to the center of the bottom bulls in the Standing position. Target holders that would be adjustable through this range would be best.

### **6.9 Wind Flags**

- (a) Tournament sponsors, only, may erect the desired number of flags or other devices to indicate wind direction forward of the firing line. Competitors may not change or add thereto but they may use wind indicating devices at the firing line as long as they do not interfere with other competitors or range operations. (See Rule 3.9.1)
- (b) Where a firing point is enclosed (see Rule 6.3) in such a manner as to prevent competitors from being exposed to prevailing winds, the tournament sponsor shall erect a row of wind flags or other devices parallel to the targets to indicate wind direction at approximately the target line and midway thereto spaced between the firing lanes of at least every fourth point. Competitors may not change or add thereto but they may use wind indicating devices at the firing line as long as they do not interfere with other competitors or range operation. (See Rule 3.9.1)

## **7. COURSES OF FIRE**

*The following courses and types of fire are most commonly found in NRA Sanctioned Smallbore Rifle Competition, fired on standard NRA targets described in Section 4. See Section 8 for the time allowances. Rule 17.5 for courses of fire for which National Records are recognized, and Rule 19.4 for courses of fire used for classification.*

*Other courses of fire, other time limits, or the use of other targets may be scheduled by sponsors provided the conditions are clearly stated in the program.*

**7.1 Courses of Fire** - In 50 yard, 50 meter, 100 yard matches it is customary to change targets after each 20 shots. The Time Limit shall be the same for the first and second 20 shots, even though it is at the same distance. (See Rule 8.2 for time allowances.)

The customary number of shots on record bulls at each distance are as follows: 50 feet, 1 shot; 50 yards/meters, 5 shots; 100 yards and beyond, 10 shots per bull. The following are the courses and types of firing commonly found in competition.

## 7.2 Conventional Prone

<i>Distance</i>	<i>Target</i>	<i>No. of Shots Per Match</i>	<i>Per Bull</i>
50 Yards	A-23/3, A-23/5	40	5
50 Meters/Yards	A-26/A-27	40	5
100 Yards	A-25	40	10
Dewar Course	A-25/5, A-25	20 each distance	5/10

### 7.2.1 Conventional Prone

<i>Distance</i>	<i>Target</i>	<i>No. of Shots Per Match</i>	<i>Per Bull</i>
50 Yards	A-23/5	20	5
50 Meters/Yards	A-26/A-27	20	5
100 Yards	A-25	20	10

## 7.3 Conventional Position Indoor and Outdoor

<i>Distance</i>	<i>Target</i>	<i>No. of Shots Per Match</i>	<i>Per Bull</i>
50 Feet (Junior Sectional 10 shots, open sectional 20 shots in each position)	A-17	10, 20, or 40 in each of the four positions	1
75 Feet	A-7/5, A-7/10	10 or 20 in each of the four positions	2
50 Yards	A-23/3, A-23/5	10, 20, or 40 in each of the following positions: Prone, Sitting, Kneeling, Standing	5

*Note: Sitting may be eliminated to shoot a Conventional 3-Position Course*

## 7.4 Metric Prone Course of Fire

<i>Distance</i>	<i>Target</i>	<i>No. of Shots Per Match</i>	<i>Per Bull</i>
50 Meters/Yards	A-50/A-51	40 or 60	5
100 Yards	A-33	40 or 60	10
Dewar Course	A-50/A-51, A-33	20 each distance	5/10

### 7.4.1 Metric Prone

<i>Distance</i>	<i>Target</i>	<i>No. of Shots Per Match</i>	<i>Per Bull</i>
50 Meters/Yards	A-50/A-51	20	5
100 Yards	A-33	20	10

### 7.5 NRA Metric Position, Indoor and Outdoor Courses

<i>Distance</i>	<i>Target</i>	<i>No. of Shots Per Match</i>	<i>Per Bull</i>
50 Feet (Junior Sectional 20 shots, open Sectional 40 shots in each position)	NRA/USAS-50	10, 20, or 40 in each position: Prone, Standing, and Kneeling.	1
50 Meters/Yards	A-50/A-51	10, 20, or 40 in each position: Prone, Standing, and Kneeling	5

### 7.6 Conventional Prone One Day

<i>Distance</i>	<i>Target</i>	<i>No. of Shots Per Match</i>	<i>Per Bull</i>	<i>Sights</i>
50 Yards	A-23	40	5	Met
Dewar Course	A-23/5, A-25	20 ea distance	5/10	Met
50 Meters/Yards	A-26/A-27	40	5	Any
100 Yards	A-25	40	10	Any

**7.7 Long Range Conventional Prone - (200 Yards)** - This event is no longer used for classification or National Records. If a sponsor desires to conduct this event, Target A-21 may be used or it may be fired on high power ranges using regulation high power targets, pit operation and scoring procedures. (High Power Rules 4, 10, and 14.)

### • 7.8 Mini Palma

<i>Distance</i>		<i>Target</i>	<i>No. of Shots</i>	<i>Per Bull</i>	<i>Sights</i>
100 Yards	Simulated 800 YD	A-37	Unlimited	5 record shots	Met
100 Yards	Simulated 900 YD	A-38	Unlimited	5 record shots	Met
100 Yards	Simulated 1000 YD	A-39	Unlimited	5 record shots	Met

*15 shots per target/45 Shots per Match*



## 8. TIME LIMITS

**8.1 Computing Time** - Time is not checked on each shot. The time allowance is computed for a complete stage (including sighting shots when specified) on the basis of the specified number of shots multiplied by the allowances per shot. The Chief Range Officer may terminate any relay before completion of the full time allowed, if all competitors in that relay have completed firing. Time allowed, but not used, does not carry over to another string or stage.

### 8.2 Time Allowance

- (a) Indoor Conventional Matches (A-17 target or its equivalent). One minute per record shot prone, sitting and kneeling. 1 ½ minutes per shot standing.
- (b) Outdoor Conventional Prone, Metric Prone and Position matches. One minute per record shot prone and 1 ½ minutes per record shot for Sitting, Kneeling, and Standing positions will be allowed.
- (c) Indoor and Outdoor NRA Metric Position Course Matches. One minute per record shot for prone and 1 ½ minutes per record shot for kneeling and 2 minutes per record shot for the standing positions will be allowed.

The competitor will be allowed a minimum of an additional 5 minutes for each position change in a stage or match. Additional time will be allowed for a target change if needed. In matches at more than one range or stage when firing must cease to change targets or stages, time may not be accumulated at one range or stage and used at another range or stage. Time for each range or stage will be allotted separately.

For one Relay Outdoor Prone Tournaments sponsors shall allow sufficient time between fired matches, minimum 20 minutes.

**8.3 Team Time** - The following will apply for firing other than when pits are used.

- (a) In matches where sufficient firing points are assigned each team so all team members fire at the same time, the total team time will be the same as the time allowed in an individual match (or stage) of same type.
- (b) In matches where sufficient firing points are assigned each team to permit all team members to fire at the same time but in which teams fire in pairs, the total "team time" will be the time allowed in an individual match (or stage) of same type multiplied by the number of pairs firing separately for each team, plus 3 minutes for each change of pairs. (Example: 4 shooters (2 pairs) per team. Dewar course, time allowed each pair at 50 yards is 20 minutes plus 3 minutes for changing pairs or the total team time at 50 yards of 43 minutes. Total team time at 100 yards is also 43 minutes.)
- (c) In matches where sufficient firing points are assigned each team to permit all team members to fire at the same time but in which team members fire singly, the total team time will be the time allowed in an individual match (or stage) of same type multiplied by the number of individuals firing separately for each team, plus 3 minutes for each change of shooters. Example: 4 shooters per team, 4 position match, standing stage, 10 shots at 50 feet, target carriers being used. Firing time is 15 minutes per team member multiplied by 4 team members or 60 minutes, plus 3 changes of shooters at 3 minutes making total team time 69 minutes.

- (d) In matches where team members will fire consecutively on the same firing point, the total team time will be the time allowed in an individual match (or stage) of the same type, multiplied by the number of team members concerned. Example: 4 shooters per team, 4 position match, Kneeling stage, 10 shots per team, target carriers being used. Firing time 10 minutes per team multiplied by 4 team members is 40 minutes, plus 3 changes of shooters at 3 minutes each making total team time 49 minutes.
- (e) Time is not kept on each team member individually unless firing as in (a) above, but the total time for the team is allowed and may be used by the team as a whole.
- (f) In matches at more than one range, stage, or where a change of targets is required during the match and carriers are not used, time may not be accumulated at one range or stage and used at another range or stage. (See Rule 8.2)

**8.4 Passage of Time** - Range Officers will not voluntarily warn competitors of the passage of time. Competitors, and Team Captains in team matches, may inquire of Range Officers as to the time remaining before expiration of the time limit. The request for time and the response shall be given in a tone which will not disturb other competitors.

## **9. COMPETITION REGULATIONS**

**9.1 Changing Rifles** - No competitor will exchange his rifle or the stock of his rifle during the firing of any single or multiple stage match (except in aggregate matches), unless it has become disabled and has been so designated by the Chief Range Officer. For the purpose of this rule, the firing of a match is considered to have started when the competitor has fired his first record shot. Claim that a rifle is disabled must be made immediately. All shots fired up to the time that the claim is made will stand as part of the official score. (Exception: Stocks may be changed at NRA 3-Position team matches at Regionals and Nationals.)

*Changing butt plate assemblies does not constitute changing rifles.*

**9.2 Fouling and Sighting Shots** - Fouling and sighting shots are permitted at any time unless prohibited by the program. They will only be fired upon the command **COMMENCE FIRING**.

### **9.2.1 Misplaced Sighting Shots**

- (a) *Indoor* - When the official target used provides a sighting bullseye, and the first sighting shot hits outside of the guard ring on the sighting bullseye on the A-17 target or NRA/USAS-50 target, measured to the near edge of the bullet hole, the competitor will inform the Range Officer of the location of such shot; the Range Officer will indicate to the Statistical Officer the value and location of the bullet hole. No such claim will be allowed after the competitor has fired more than one shot on a target card. Any additional misplaced sighting shots will be scored as record shots.
- (b) *Outdoor* - When the first sighting shot hits below an imaginary or transcribed line midway between the sighter and record bullseyes (not touching the line with aid of scoring gauge), the competitor will inform the Range Officer of the location of such shot before firing another shot on the target card: the Range Officer will indicate to the Statistical Officer the value and location of the bullet hole. No such claim will be allowed after the competitor has fired more than one shot on the target card. After the first sighting shot any additional shot below an imaginary or transcribed line midway between the sighter and record bullseye (not touching the line with aid of scoring gauge), will be considered a record shot.

**9.4 Defective Cartridge** - A defective cartridge is one:

- (a) Which has such evident structural defect as to cause misfire or cause a rifle to fail to function
- (b) Which does not fire
- (c) From which the bullet has not left the barrel. (No claim for a defective cartridge shall be allowed if bullet has left the barrel except in the incident of a ruptured case. The Range Officer will indicate to the Statistical Officer the value and location of the bullet hole.)

(For procedure in case of a defective cartridge see Rule 10.9. For re-firing privileges, see Rule 9.14.)

**9.5 Disabled Rifle** - Any rifle which cannot be properly aimed or safely fired may be declared disabled. Sights improperly adjusted do not constitute a disabled rifle. A rifle once declared disabled by the Range Officer shall not be used again for competition firing until the defect has been corrected and the rifle has been ruled as safe by the Chief Range Officer. (For procedure in case of a disabled rifle see Rule 10.9. For re-firing privileges see Rule 9.14.)

**9.6 Malfunction** - Failure of the rifle to function properly due to mechanical defects or to defective ammunition. Functional failures, due to improper manual operation are not to be considered as malfunctions. (For procedure in case of a malfunction see Rule 10.9. For re-firing privileges see Rule 9.14.)

**9.7 Continue to Fire** - Competitors who fire a perfect score (all X's on targets with an X-ring or all tens on targets without X-rings) in an individual match will be given an opportunity to continue to fire to provide a means of breaking ties and establishing National Records over those courses for which National Records are recognized. This continuation of firing may be either immediately following the match in which the perfect score was fired or later, whichever is most practical, however, scores from a succeeding match cannot be used. The continuation of firing must in all cases commence during the day of the match in which the perfect score was fired. Firing time and firing conditions will be the same as for the match in which the perfect score was fired. Firing will continue until a hit is made outside the ring of highest value. (X-ring where target provides an X-ring.) On multiple bullseye targets firing will be continued on bullseyes in the order numbered and only those bullseyes with perfect scores (all X's where the target provides an X-ring) will be considered. The total score (original match score and the score in the continuation of firing) will be used to establish new records and for breaking ties in the match concerned. Firing is not continued for perfect scores fired in team matches. When a perfect score is fired in an event comprised of stages fired in more than one position, the continuation of firing for National Record purposes will be done in Standing. When a perfect score is fired in an event comprised of stages fired in more than one range, the continuation of firing for National Record purposes will be done at the longer range. (See Rule 17.2)

**9.8 Weighing Triggers** - Triggers may be weighed with official NRA trigger test weights, at the discretion of the Match Director, Official Referee, or Jury except in those matches conducted under Rules 3.2 and 3.4. Failure of the trigger to meet the trigger pull requirements shall disqualify the competitor in matches previously fired. While the trigger pull is being weighed, the rifle shall be held with barrel perpendicular to the horizontal surface on which test weight is supported. The rod or hook of test weight shall rest on the lowest point of the curve in curved triggers or on a point

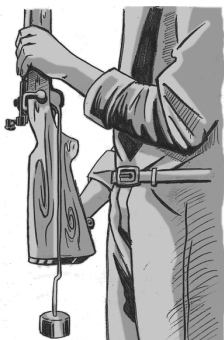

approximately ½ inch from the lower end of straight triggers. To pass the weight test, a weight of the correct number of pounds shall be lifted by the rifle trigger while in the cocked position and while all safety devices are in firing positions, from the horizontal surface on which it is resting, until the weight hangs free and without releasing the trigger. Competitors will be permitted to adjust triggers which have failed to pass the weight test provided they do not occasion any delay. Failure of the trigger to pass the weight test is the competitor's responsibility.

**9.9 Competitor's Position** - A competitor will take his position on the firing line as directed by the Match Officials. No portion of the shooter's body may rest upon or touch the ground in advance of the firing line. This does not prohibit equipment from being placed forward of the firing line. (Rules 3.8, 3.9 and 3.9.1.)

**9.10 Coaching Prohibited in Individual Matches** - Coaching is prohibited in all individual matches of a Registered Tournament. If a competitor wishes to speak with his coach or leader, he must unload his firearm, leave it in a safe condition on the firing line and leave the firing line to confer with coach or leader, being careful not to disturb other competitors. (Exception see Rule 19.4.1.)

*For this rule, coaching is defined as receiving unauthorized individual assistance, forward of the ready line, from any outside source.*

### **9.11 Matches Not Complete**

- (a) *Individual matches not complete* - When a match or stage is not completed by all competitors in accordance with the tournament schedule, the match or stage may be rescheduled or cancelled. Any match or stage which has been completed by all competitors will not be refired. Only scores of a match or stage which has been completed will be included in an aggregate event or for National Record purposes, and a match or stage is not completed unless all competitors have fired.
- (b) *Team matches not complete* - When all stages of a team match are not completed by each team member in accordance with the tournament program, the following applies: If all teams have fired an equal number of record shots, all fired shots will count as the team total score. Only when teams have fired an unequal number of record shots at the cancellation point, will record shots be thrown out to a point where team equality is achieved.

**9.13 Interference** - With the exception of competitors actually firing and such range personnel as may be necessary, the firing points and lines will be kept clear at all times. Competitors will not be permitted to interfere with the handling of targets by range personnel.

### **9.14 Refiring**

- (a) No competitor will fire more than one score for the same award except as provided in the program or in accordance with Rule 9.11.
- (b) No competitor will be allowed more than one refire because of the defective cartridge, disabled rifle or malfunction.

**9.23 Aliases** - No competitor may fire under an assumed name nor may he substitute for another in a match; register, enter or fire in the name of another.

**9.24 Score and Classification Falsification** - No competitor will falsify his score, or classification, nor that of any other competitor, nor be an accessory thereto.

• **9.25 Cross-Fires and Excessive Hits**- No competitor will deliberately fire on the wrong target nor fire more than the required number of shots, including hits on another competitor's target card.  
*See rule 18.15(h) Responsibility.*

**9.26 Bribery** - No person will offer a bribe of any kind to any of the range, statistical personnel, or others, nor be an accessory thereto.

**9.27 Disorderly Conduct** - Disorderly conduct or intoxication is strictly prohibited on the range and anyone guilty of same will be expelled from the range. Expelled competitors will be disqualified from the competition with no return of entry fees. (See Rule 9.30)

**9.27.1 Willful Destruction of Range Equipment** - No competitor shall cause any range equipment to become damaged through a deliberate act and anyone guilty of same will be expelled, without a warning, from the range. Expelled competitors will be disqualified from the competition with no return of entry fees. (See Rule 9.30) "Intentionally disturbing another competitor is considered disorderly conduct."

**9.28 Refusal to Obey** - No person will refuse to obey instructions of the Tournament Officials, if instructions are given in the proper conduct of their office. (See Rule 9.30)

**9.29 Evasion of Rules** - No competitor will evade nor attempt to evade nor be an accessory to the evasion of any of the conditions of a match as prescribed in the program or in these rules. Refusal of a competitor or Tournament Official to give testimony regarding facts known to him concerning violations or attempted violations of these rules will constitute being an accessory to the violation or attempted violation. (See Rule 9.30)

**9.30 Penalties/Disqualifications** - In cases of infringement and contravention of the regulations or of the instructions of Range Officers by an individual shooter, team shooter or non-firing team member, the following penalties may be imposed upon the individual competitor, team member or team by the Match Director, Referee or Jury:

Warning

Deduction of points from the score

Disqualification.

In case of infringement of the regulations:

- (a) A warning may be given so that the competitor/team official may have the opportunity to correct the fault. In the case of a serious violation of safety regulations, the Jury or Referee has the authority to impose immediate disqualification on the competitor or team official.
- (b) If the competitor/team official does not correct the fault before the next shot, 10 points shall be deducted from his score or the team score.
- (c) For a repeated infringement, the competitor/team official may be disqualified.
- (d) A warning to the competitor must be expressed in such terms as will leave no doubt that it is an official warning. A warning to the competitor, whenever it is possible, should be given so

as not to disturb him while firing a shot, unless the infringement concerns safety, in which case the competitor shall be warned immediately.

- (e) If a competitor continues to handle his firearm in a dangerous manner, or continues to violate any of the safety regulations, he may be disqualified.
- (f) If the Range Officer, Referee or Jury is of the opinion that the competitor has attempted to intentionally circumvent the rules or disturb other competitors in an unsportsmanlike manner, he may be warned, then penalized by the deduction of 10 points from his score, or he may be disqualified.
- (g) If the Range Officer, Referee, or Jury considers that the competitor is holding up the procedure unnecessarily, with the intention of gaining unfair advantage, he may be warned, then for every similar fault thereafter, 10 points may be deducted from his score.
- (h) The discharge of any firearm anyplace other than the firing line, or the firing line prior to the shooters being placed in the preparation period, will result in disqualification and expulsion from the tournament with no refund of fees. If a firearm is discharged while the shooters are in the preparation period prior to the command **LOAD** it will result in the competitor being disqualified from that fired match.
- (i) Any competitor placing an unfired cartridge in the chamber, on the loading ramp or in the magazine before the command **LOAD** will be warned on the first violation, disqualified from that stage for the second violation, disqualified from the match for the third violation, and expelled from the tournament on the fourth violation, with no refund of fees.

*All irregularities, penalties, misses, malfunctions, extra time allowed, repeated shots or repeated series, annulment of shots, etc., must be clearly marked and recorded in a log, and on both the target and score card, by the Range Officer or by the responsible official on the range. Penalty points will be deducted from the stage or match in which the infraction has occurred, starting from the last bull fired in the stage or match.*

**9.31 Suspension** - For violations of these Rules deemed so to justify, any competitor may be suspended from competition and/or expelled from the National Rifle Association upon presentation of evidence and conduct of a hearing as prescribed in the Bylaws.

*In as much as the commission of any of the foregoing offenses, Rule 9.23 through 9.31, are of such importance as to be major offenses, all of the foregoing that may merit action under Rule 9.31, shall be sent to the NRA Protest Committee. The complaint shall be in writing, notarized and signed by the complainant.*

## **10. RANGE COMMANDS, CONTROL, AND OPERATIONS**

**10.1 Discipline** - The safety of competitors, range personnel and spectators requires continuous attention by all to the careful handling of firearms and caution in moving about the range. Self-discipline is necessary on the part of all. Where such self-discipline is lacking it is the duty of the range personnel to enforce discipline and the duty of competitors to assist in such enforcement.

*Under no circumstances shall firing commence or continue on a range where an unsafe condition exists.*

**10.1.1 Actions Open** - Unless the rifle is cased, the action must remain open at all times and the empty chamber indicator (ECI) inserted in the chamber. No competitor will aim toward the targets until the proper command is given. No rifle will be handled in any manner to violate any rule of safety.

**10.1.2 Rifles Unloaded** - Rifles will not be loaded until the competitor has taken position at his firing point, rifles pointed toward the targets and the command **LOAD** has been given. (Rules 9.30 (h) and (i))

**10.1.3 Loaded Rifles** - No loaded cartridge will be inserted into the rifle nor placed on the loading ramp except at the firing point and under the command **LOAD**. The muzzle of the rifle will be pointed in the direction of the targets and will be forward of the firing line until the rifle is discharged or unloaded.

#### **10.1.4 Cease and Commence Firing**

**(a) Cease Firing** - All shooters will immediately stop firing upon the command **CEASE FIRING**. Actions will remain open (see Rule 14.5) and an ECI inserted in the chamber.

*“Cease” is the preparatory part of the command and “Firing” is the action part of the command. NO shot should be fired after the word “Firing” is spoken.*

**(b) Commence Firing** - All shooters may start firing upon the command **COMMENCE FIRING** as the timing of the string is started with this command. (See Rule 14.5)

*“Commence” is the preparatory part of the command and “Firing” is the action part of the command. NO shot will be fired before the word “Firing” is spoken.*

**10.1.5 Not Ready** - It is the duty of competitor(s) to notify the Range Officer if not ready to fire at the time the Chief Range Officer asks **IS THE LINE READY?** Failure of competitor(s) to notify the Range Officer that he is not ready means he forfeits his right to refire.

Notes:

1. If a competitor is not ready through no fault of his own, he will be given an opportunity to explain. If satisfactory, the competitor will be permitted to refire at a later time or simply allowed to fire with his relay and given additional time to make up for time lost.
2. If the competitor is not ready because of his own actions, he will be required to fire within the appropriate time on his appropriate relay.

**10.1.6 Loading in Slow Fire** - In all slow fire events, the rifle will be loaded with only one cartridge at a time.

**10.1.8 Checking Targets in Multiple Stage Match** - When targets for more than one stage are framed at once, the Range Officers will inspect targets between stages. Any hits fired by the competitor on targets for the wrong stage will be marked by the Range Officer. The competitor will be credited with all shots actually fired for each stage but will be penalized one point for each shot thus fired in error.

**10.1.9 Ranges with Target Carriers** - When a range is equipped with a carrier system permitting the changing of targets from the firing line without suspending firing, competitors may be issued the targets necessary to complete the match. Each competitor will be responsible for the hanging of his target properly on the target carrier. Fired targets will be gathered by the Range Officer as soon as each stage is completed.

**10.2 Loud Language** - Loud or abusive language will not be permitted. Competitors, scorers and Range Officers will limit their conversation directly behind the firing line to official business.

**10.3 Delaying a Match** - No competitor may delay the start of a match through tardiness in reporting or undue delay in preparing to fire. (See Rule 18.7)

**10.3.1 Preparation Period** - (The preparation period will begin only after the shooters have been given time to bring their rifles to the line.) In all cases competitors will be allowed a minimum of three minutes to take their places at their firing points and prepare to fire at the beginning of each match, after the firing point has been cleared by the preceding competitor. The ECI may be removed and dry firing shall be permitted during this period. In all cases before the second stage of a two-stage match there will be a preparation period of a minimum of one minute. A three minute preparation period will be given after a range change.

*Range Officials may allow a reasonable period of time (5 minutes) for equipment set-up before the beginning of the three minute preparation period.*

**10.3.2 Interrupted Fire** - If firing is halted for two minutes or more, a preparation period of a minimum of one minute will be given, and one minute will be added to the firing time remaining, for any additional sighters needed, when firing is resumed.

**10.4 Policing Range** - It is the duty of competitors to police the firing points after the completion of each stage. The Range Officers will supervise such policing and will see that the firing points are kept clean.

**10.5 Competitors Will Score** - Competitors will act as scorers when requested to do so by the Match Director or Chief Range Officer, except that no competitor will score his own target.

**10.6 Repeating Commands** - A Range Officer will repeat the Chief Range Officer's commands only when those commands cannot be clearly heard by competitors under his supervision.

**10.7 Firing Line Procedures and Commands** - When ready to start the firing of a match the Chief Range Officer commands **RELAY NO. 1 MATCH NO ...** (or naming the match) **ON THE FIRING LINE**. Competitors in that relay may set up their equipment on their assigned firing points but will not bring their rifle to the firing line until called to do so by the Chief Range Officer.

After the down range area is clear, targets are hung and all shooters and match personnel are behind the firing line the Chief Range Officer commands, **RELAY ... YOU MAY BRING YOUR RIFLES TO THE LINE, ECIs MUST BE INSERTED IN YOUR CHAMBERS.**

The Chief Range Officer states, **YOUR \_\_\_\_ MINUTE PREPARATION PERIOD STARTS NOW.**

Range Officers check the location of each competitor as to correct firing point by comparing the number of each competitor's firing point with the relay and target number on his score card or on the range



assignment card. At the end of the preparation period the Chief Range Officer states, **YOUR PREPARATION PERIOD HAS ENDED.** After ascertaining that the range is clear, he proceeds with the range firing commands. The Chief Range Officer then asks, **IS THE LINE READY?** Any competitor who is not ready or whose target is in bad order, will immediately raise his arm and call, **NOT READY ON TARGET....** The Chief Range Officer will immediately state **THE LINE IS NOT READY,** and the Range Officer will immediately investigate the difficulty and assist in correcting it. (See Rule 10.1.5)

When the difficulty has been corrected, the Chief Range Officer calls, **THE LINE IS READY.**

When the Chief Range Officer asks, **IS THE LINE READY?** and the line is ready, he then calls, **THE LINE IS READY.**

If the size of the line requires it for safety, the Chief Range Officer will state the following: **READY ON THE RIGHT, READY ON THE LEFT, READY ON THE FIRING LINE.**

The Chief Range Officer then commands **LOAD.** Rifle chambers may be loaded.

The Chief Range Officer then commands **COMMENCE FIRING.** At the latter command he starts his stop watch or makes note of the time and at the end of the time limit commands **CEASE FIRING—BOLTS OPEN, INSERT YOUR ECIs.** All rifle chambers and magazines are unloaded and competitors leave the firing line with the actions of their rifles open.

*In a two relay match, in order to facilitate a smooth and safe change over, competitors are urged to remove their equipment as soon as they are finished firing. Competitors are reminded that if other competitors to the right or left are still firing they should quietly remove only the equipment they can comfortably carry with them (rifle, spotting scope), returning to remove the balance of their equipment only after the adjacent competitor(s) is done.*

*In a two relay match, competitors on the relay coming to the line are encouraged to bring their equipment including rifles to the line when their firing point and the firing points to the right and left of their firing point are clear.*

*Shooters are reminded that there will be **no** handling of firearms forward of the ready line while shooters are down range.*

Before competitors are allowed down range, the Chief Range Officer should ask **IS THE LINE CLEAR?** This means that all rifles on the line are unloaded, all bolts are open, and ECIs are inserted. Upon receiving confirmation from the Line Officers that all rifles are clear, say **THE LINE IS CLEAR.** Additional instructions are proper at this time such as **GO FORWARD AND CHANGE TARGETS OR REMOVE YOUR EQUIPMENT FROM THE LINE FOR THE NEXT RELAY.**

Succeeding relays are handled in like manner.

Range Officers will immediately command **CEASE FIRING—BOLTS OPEN, INSERT YOUR ECIs** if any incident occurs which indicates possible injury to some living thing should firing continue. In all other cases commands will originate with the Chief Range Officer.

Should a target blow out of the frame or otherwise become unserviceable, the Range Officer will report the condition immediately to the Chief Range Officer who will issue such commands and directions as seem advisable to him.

*See Rules 10.7.1 and 18.15(e)*

Other commands used less frequently are:

**POLICE FIRING POINTS** means pick up fired cartridge cases, empty cartridge cartons and tidy-up the firing line. **AS YOU WERE** means disregard the command just given. For example, if the commands were given **THE LINE IS READY** followed by **AS YOU WERE** it would mean someone was not ready. **CARRY ON** means proceed with whatever was being done before some interruption occurred.

**10.7.1 Range Alibis** - Refires are allowed through faulty or improper range procedure and or weather, such as, targets of a relay rendered unscorable or unshootable because of extreme weather conditions (wind/rain).

**10.9 Procedure in Case of Defective Cartridge, Disabled Rifle or Malfunction** - If a cartridge fails to fire or a rifle fails to function, the competitor will call the Range Officer. The Range Officer, when satisfied that there is a defective cartridge (Rule 9.4), disabled rifle (Rule 9.5), or malfunction (Rule 9.6), will permit the competitor to replace the unfired cartridge or clear the jam and continue firing. Additional time may be allowed each competitor, equal to the time lost because of the defective cartridge, disabled rifle or malfunction. It is not required that the Range Officer attempt to fire a cartridge before it is declared defective.

**10.10 Electronic Scoring Targets** - Electronic scoring targets are authorized for all events.

#### **10.10.1 Target Officer** - Electronic Scoring Targets

- (a) Target Officers must ensure that there are no shot holes on the white surface of the target, and that any shot marks on the frame are clearly indicated, patch the Backing Targets and the Backing Cards and change the Control Sheets.
- (b) Backing Cards and Control Sheets must not be patched or changed until after all scoring is completed.

#### **10.10.2 Technical Officers** - Electronic Scoring Targets

- (a) Technical Officers may be appointed to operate and maintain the Electronic Scoring Target equipment; they may offer advice to Range Officers and Jury Members but must not make any decisions.
- (b) Prior to the commencement of each relay of an event, a Jury Member must inspect the Electronic Scoring Targets to confirm the following:
  - (1) There are no shot holes on the white surface of the target.
  - (2) Any shot marks on the frame are indicated clearly.
  - (3) Backing Cards are free of shot holes.
  - (4) Control Sheets are renewed.

**10.10.3 Procedure for Examination of Electronic Scoring Targets following a Score Protest, Complaint, No Indication, etc.**

- (a) A Jury Member collects the following items (and the number of the firing point and the orientation of the card, sheet or target, the relay and series and the time of collection must be noted on each):

- (1) Control Sheet. If the location of any shot hole is out of the area of the Control Sheet, the geometric relation between the shot holes on the Control Sheet and the Backing Card must be made before the Control Sheet is removed.
  - (2) Backing Card (50 m/yd)
  - (3) Black Paper Strip (10 m); 50 ft
  - (4) Black Rubber Band (50 m)
  - (5) Range Report knowledgeable
  - (6) LOG-Print
  - (7) Data record from the electronic scoring target computer (if necessary).
- (b) A Jury Member must examine the face of the electronic scoring target, and the frame, and record the location of any shots outside the black aiming mark.
  - (c) No CLEAR LOG must be made before the Jury has given permission.
  - (d) The number of shot holes must be counted and their location taken into account. The Jury Members must examine the items above and then make independent assessments before a formal Jury decision is made.
  - (e) A Jury Member must supervise any manual intervention of the control computer results (e.g., introduction of penalties, corrected scores after malfunctions, etc.).

#### **10.10.4 Cross-Fires**

- (a) Cross-fires of competition shots must be scored as misses. If a shooter fires a sighting shot on the competition target of another shooter, he must be penalized by deduction of one (1) point from his own score deducted from the first series. Rules 9.25 and 14.10
- (b) If a shooter fires a sighting shot on the sighting target of another shooter no penalty is incurred.
- (c) If a shooter receives a confirmed cross-fire shot and it is impossible to determine which shot is his, he must be credited with the value of the highest undetermined shot.
- (d) If there are more hits on a shooter's competition target than are provided for in the program, and if it is impossible to confirm that another shooter(s) fired the shot(s), the hit(s) of the highest value must be nullified.
- (e) If a shooter wishes to disclaim a shot on his target, he must report this immediately to a Range Officer.
- (f) If the Range Officer confirms that the shooter did not fire the disputed shot(s), he must make the necessary entry on a Range Report the shot must be annulled.
- (g) If the Range Officer cannot confirm beyond all reasonable doubt that the shooter did not fire the disputed shot(s), the shot(s) must be credited to the shooter and must be so recorded.

- (h) The following must be considered as reasons to justify the annulment of a shot:
  - (1) If the Range Official confirms by his observation of the shooter and the target that the shooter did not fire the shot;
  - (2) If a missed shot is reported by another shooter or other Range Official at approximately the same time, and from within the neighboring two or three firing points.

### **10.10.5 Failure of Electronic Scoring Target Systems**

- (a) In the event of a failure of ALL the targets on a range:
  - (1) The time of failure and the expired shooting time must be recorded by the Chief Range Officer and the Jury.
  - (2) All completed competition shots of each shooter must be counted and recorded. In the event of a range power supply failure, this may involve waiting until the power supply is restored to enable the number of shots registered by the target, not necessarily on the firing point monitor, to be established.
- (b) After the failure is rectified and the full range is in operation, an additional five (5) minutes will be added to the competition time remaining. The time for recommencing is to be announced over the loudspeaker system at least five (5) minutes beforehand. Shooters must be allowed to resume their position in the five (5) minutes before the competition restarts. Unlimited sighting shots must be allowed during the remaining shooting time, but only before competition shots are resumed.
- (c) Procedure of the failure of a SINGLE target.

If the Electronic Scoring Target cannot be repaired within five (5) minutes, the shooter will be moved to a reserve position and when he is ready to shoot, an additional five (5) minutes will be added to the competition time remaining. He will be permitted unlimited sighting shots.
- (d) Complaint concerning failure to register or display a shot on the monitor of an Electronic Scoring Target system.
  - (1) The shooter must immediately inform the nearest range official of the failure. A Range Official must make a written note of the time of the complaint. One or more Jury Member(s) must go to the firing position.
  - (2) The shooter will be directed to fire one more aimed shot at his target.

If the value and location of this shot is registered and displayed on the monitor, the shooter will be directed to continue the competition. The value, location and time of firing of this extra shot must be recorded, its shot-number (having included the missing shot) and its value and its shot-location, and the firing point number must be given to the Jury in writing and an Accident Report.

After the end of that relay of the competition, the Procedure for Examination of Electronic Scoring Targets will be applied. Using this information and the time of

the extra shot and its location, the Jury will determine whether all shots, including the extra shot are recorded on the computer record.

If all the shots are recorded correctly, then the questioned shot will be counted in the score of the shooter, as well as the shot fired immediately after (as the “extra” shot), but the last shot fired (extra to the competition) will be annulled.

If the questioned shot has not been located applying the Procedure for Examination of Electronic Scoring Targets nor elsewhere, then only those correctly recorded shots excluding the last shot fired (extra to the competition) are to be counted in the score of the shooter.

If the questioned shot has not been located in the computer memory, but is located elsewhere, the Jury will determine the validity and score-value of the questioned shot.

- (3) If the extra shot fired as directed does not register or display and the Electronic Scoring Target cannot be repaired within five (5) minutes, the shooter will be moved to a reserve position and when he is ready to shoot, an additional five (5) minutes will be added to the competition time remaining. He will be permitted unlimited sighting shots.

The shooter will repeat the two (2) competition shots which did not register nor display on the previous target used.

- (4) The shooter will be credited with the score of all the shots which were displayed on the monitor of the first target plus the score of all the properly fired competition shots which were displayed on the second target used. If the two (2) extra shots were later found in the computer record of the previous target they will be annulled.
- (5) If a shooter complains during sighting shots about the correct recording or evaluation of the shot(s), the Jury may offer to move him to another firing point. The shooter is given appropriate extra time. The Jury examines the sighting shot(s) as soon as possible applying the Procedure for Examination of Electronic Scoring Targets on the original firing point.

If this subsequent examination shows that the target on the original firing point provided correct results, the shooter will be penalized with the DEDUCTION of one (1) point from the lowest value shot of the first competition series.

- (e) Failure of the paper or rubber band.

If Jury decides that the problem is because of the failure of the paper or rubber band to advance, the shooter will be moved to a reserve position. He will be permitted unlimited sighting shots to be taken within the time remaining for the competition plus any additional time granted. Then he will repeat the number of competition shots determined by the Jury. The shooter will be credited with the score of all the shots which were correctly displayed on the monitor of the first target plus the score of all the necessary competition shots fired on the second target to complete the course of fire. After the relay the Jury will decide which shots are to be counted from each target.

- (f) Challenge concerning the shot value Electronic Scoring Targets.
  - (1) After the relay, the detailed printer results (LOG-Print) must be generated by the Technical or Range Officers for all firing lanes on which complaints or protests have been made, and for the immediately adjacent lanes, before the equipments are reset for the next relay.
  - (2) After the completion of the relay, the Procedure for Examination of Electronic Scoring Targets will be applied. Any non-indicated shot must be scored by the Jury.

**10.10.6 Calibration of Electronic Scoring Devices** - Electronic scoring devices that score paper targets must be calibrated before the start of the match. If recalibration is necessary during the match, all prior targets must be re-scored using the new calibration.

**10.10.6.1 Challenge of Paper Targets Scored by Electronic Devices**- If a challenge to the score is made, the individual bull must be challenged. The shot will be plugged using the appropriate scoring gauge ( Rule 14.3 ). The decision of the Referee or Jury is final.

## 11. TOURNAMENT OFFICIALS

***Tournament Officials** - Officials will be thoroughly familiar with conditions of the program and with National Rifle Association Rules. Officials may compete in Approved, Registered, State and Regional Tournaments. National Championship match officials may not compete.*

**11.1 Match Director** - The Match Director is the official primarily responsible for the efficient conduct of the entire tournament. He may change match and firing conditions from those shown in the program, provided a Match Director's bulletin is posted for the information of all competitors, and that such changes are not contrary to current NRA Rules. The Match Director is also directly responsible for the efficient operation of the range and the Statistical Office and for the safety and proper discipline of all tournament operating personnel, competitors and spectators. Instructions from the Match Director for the operation of the tournament will be complied with by all persons on the range. The Match Director will use the best judgment at all times. His behavior and decisions must be characterized by absolute impartiality, firmness, courtesy and complete awareness. In the application of these Rules the Match Director will confer with the NRA Official Referee or Jury on any doubtful point and will be guided by the Official Referee's or Jury's decision.

**11.1.1 Deputy Match Director** - The Deputy Match Director, when appointed, is responsible to the Match Director for the efficient conduct of the entire tournament, and acts for the Match Director in all matters listed in Rule 11.1. A Deputy Match Director is appointed at the discretion of the Sponsor.

**11.2 Official Referee** - An Official Referee may be assigned at all NRA Sanctioned State, Sectional, Regional and National Championships. Assignments are made from Headquarters of the National Rifle Association. The NRA Official Referee is not an administrative or operating official and is not responsible for the behavior or efficiency of either range or statistical office personnel. It is the responsibility of the Referee to properly interpret and apply all National Rifle Association Rules. The Official Referee's decisions are final in scoring of challenged targets except when scoring in the pit and at National Championships. He will not score except when called on to rule on challenges. It is the Referee's duty to rule on all protests and challenges. Except in an emergency involving the safety of personnel or property, the Referee will not give instruction directly to tournament operating personnel, but will

give all such instructions through the Match Director. In the event of a disagreement between Match Officials, the Official Referee shall prevail at the match with recourse only to the Protest Committee. The NRA Official Referee may not change the NRA Rules as printed herein or as officially amended. It is the duty of the Referee to render a complete report to the National Rifle Association covering all phases of the tournament. The Referee may disqualify all or any portion of the score, if, in the Referee's opinion, the conditions warrant such action. A report will be submitted on any Tournament Official who refuses to accept proper instructions given by the Official Referee. After a full hearing is held by the Protest Committee on such a report, the Association may:

- (a) Warn, suspend, or bar anyone from serving or competing in NRA competition.
- (b) Warn, suspend, or cancel Certificate of the Official Referee.
- (c) Refuse to accept for registration or approval any further tournaments conducted on the same range or by the same organization until the unsatisfactory condition reported by the Official Referee has been corrected.

Official Referees may not compete in any match fired in conjunction with any tournament where they are officiating. The Official Referee assigned to a Registered Tournament may disqualify a competitor(s) under provisions of Rule 9.30.

**11.2.1 Jury** - In all Approved or Registered Tournaments where no Official Referee is assigned, a 3-member Jury will be formed by the Match Director to function as described in Rule 11.2. One member of the Jury must be a member of the sponsoring organization, and complete the reports required by NRA. The members of the Jury may or may not be competitors in that tournament. A Jury member shall be exempted from ruling on a matter in which they are personally involved and the Match Director will name a replacement for that Jury member while ruling on that action. Under no circumstances may any Match Official (Rules 11.1, 11.1.1, 11.4, 11.5, 11.6, and 11.7) be a member of the Jury. The Jury Chairman may disqualify a competitor(s), as directed by the Jury, under provisions of Rule 9.30.

**11.4 Range Director** - When appointed, the Range Director and Deputy Range Director are responsible to the Match Director, and have supervisory responsibility for the Chief Range Officers and for the efficient and safe operation of the range.

**11.4.1 Chief Range Officer** - Will have full charge of the range and will conduct the matches on the schedule approved by the Match Director. He is responsible for range safety, and for enforcing all Rules.

**11.5 Range Officers** - Each Range Officer is an assistant to the Chief Range Officer. Competitors may be assigned this duty. He is responsible for the safety and discipline of range personnel, competitors and spectators in the sector of the range to which he has been assigned. He is responsible for seeing that the competitor's equipment and position are as authorized for the particular match being fired. It is his duty to be completely familiar with the program and with the National Rifle Association Rules. He is to comply to the best of his ability with all instructions issued by the Match Director or Chief Range Officer and will render all possible cooperation to other officials. He must be constantly alert, impartial in his handling of competitors and courteous though firm.

**11.6 Statistical Officer** - The Chief Statistical Officer is in charge of all statistical work in connection with the match except the actual recording of scores when this is done on the range. The Chief Statistical Officer is directly responsible to the Match Director. He is assisted by such Assistant Statistical Officers as may be required.

**11.6.1 Duties of Office** - It is the duty of the Statistical Office to:

- (a) Register competitors, and check their eligibility and classification.
- (b) Accept match entries.
- (c) Prepare, post and keep current a list of competitors showing name, number and classification.
- (d) Squad competitors and prepare range assignment cards where such cards are used.
- (e) When backing cards are used, compare the record target with the backing target, and determine the firing point from which shots were fired in error and indicate such information on the record card.
- (f) Check addition on score cards and correct totals.
- (g) Score targets and tabulate scores in order of merit.
- (h) Prepare Preliminary and Official Bulletins.
- (i) Maintain an Official Bulletin Board.
- (j) Determine award winners and distribute awards.
- (k) Report to Match Director, NRA Official Referee or Jury for appropriate disciplinary action any irregularities in firing or scoring which may be indicated by squadding records or score cards.
- (l) Make required reports to NRA within specified time.

**11.6.2 Retention of Records** - The statistical Office will retain in good order all completed Official Score Cards for 30 days, and all fired targets ( except those scored on frames) until the expiration of the time allowed for challenges and protests. When targets are used as score cards and transferred to a computer, the computer record becomes the official score card at the end of the posted challenge period for the match.

**11.6.3 Preliminary Bulletins** - Preliminary Bulletins on all matches will be posted promptly on the Official Bulletin Board and remain a reasonable length of time to allow competitors to notify the Statistical Office of apparent errors. The challenge closing time will be stated on each bulletin. However, where a bulletin board is used and all scores of competitors are copied thereon, such will be accepted in lieu of the above, provided a notice appears as to the close of challenge time.

**11.6.4 Official Bulletins** - Official Bulletins will be posted on the Official Bulletin Board. However, in the procedure outlined in Rule 11.6.3 for bulletin boards, such scores shall be acceptable and become final after the elapse of the challenge time period and shall act as an Official Bulletin.

**11.6.5 Correction of Bulletin Errors** - The Statistical Office will correct errors which come to the attention of the office prior to publication of the Official Bulletin.

**11.6.6 Changing Official Bulletins** - No Official Bulletin shall be changed except on authority of the Match Director, Official Referee or Jury; granted before the time has expired for challenging the last of the preliminary bulletins required to cover all the scheduled events.



Subsequent changes from the Match Director, Official Referee or Jury requesting a change, are limited to correction of:

- (a) Typographical errors.
- (b) Aggregate bulletins on which total score does not agree with the scores as shown on the Official Bulletins for the matches constituting the Aggregate.
- (c) Where an error has been made by not following the program schedule of awards.
- (d) Errors in classification of competitors, the competitor having been previously advised of such error and of correct classification.
- (e) Disqualification of competitors as provided by Rule 9.30.

**11.6.7 Individual Squadding** - Where advance entries are received, squadding for all matches may be made in advance. Competitors may be squadded so they move a predetermined distance along the firing line after each match. They may be squadded as to class, but wherever practical all of a class should fire on the same relay. Where post entries are received, they may be squadded as fill-ins to the above. Squadding of classes together will be permitted as outlined above.

**11.6.8 Team Squadding** - All team matches will be squadded with one or two adjacent targets assigned to each team and where possible all teams will fire concurrently. When enough targets are available, more than two adjacent targets may be assigned each team but only when all teams can be squadded so as to fire concurrently. Coaching within the team is permitted in team matches.

Team targets may be assigned by the Statistical Officer, or drawn by chance by the Team Captains under the supervision of the Statistical Officer or Chief Range Officer.

Team score cards will show the names of Team Officers, and each firing member and alternate. Except in matches where the targets have been marked with the competitor's name or number, Team Captains may assign team members to team targets in such order as he desires and may change the order of firing between stages.

**11.6.10 Range Assignment Cards** - When used, range assignment cards are prepared by the Statistical Office and delivered to the Range Officers prior to each match. Range Officers check competitors on the firing line to ascertain that each is on the proper firing point as indicated by the range assignment card. Should any reassignment of competitors be necessary on the firing line, Range Officers will carefully note such reassignments in the space provided on the range assignment card. These cards will be turned in to the Statistical Office immediately upon the conclusion of each relay.

**11.7 Target Officer** - The targets and frames are under the command of the Chief Target Officer and such Assistant Target Officers as may be required. Target Officers are under the command of the Chief Range Officer. The Target Officer is responsible for the safety and discipline of personnel engaged in the handling of the targets. He is responsible for the maintenance of targets in proper condition and for the efficient mounting and dismounting of paper targets during the progress of the match. When targets (either with or without backing cards) are framed for the competitor, the Target Officer is responsible that:

- (a) Record and backing target agree.
- (b) Targets are properly framed as to firing point assignment.

- (c) After firing, all targets and backing cards are properly dismounted and paired according to target point number, in proper order.
- (d) Targets are arranged in numerical order.
- (e) All targets are promptly returned to the Statistical Office at the completion of each relay or displayed on racks in proper order.

*When targets are framed by the competitor, it is the competitor's responsibility that the correct target for the range and position being fired is framed. Note: Refer to Rule 18.15(e).*

**11.8 National Championship Protest Committee** - A National Championship Protest Committee may be appointed by the Match Director at any NRA National Championship. When such a Championship Protest Committee is appointed, decisions on Protests by that Committee at the Championship are final, without appeal to the NRA Protest Committee. When possible cases of suspension from competition arise from an incident or incidents in a Championship, the Championship Protest Committee may not act, but must forward a recommendation to the NRA Protest Committee for action. No member of the National Championship Protest Committee may be a competitor in that Tournament.

A protest procedure must begin no later than one hour after the completion of firing for the day. In the case of awards, the protest must begin no later than one half hour after the completion of the awards ceremony.

**11.9 Duty to Competitors** - It shall be the duty of all operating officials and personnel to conduct themselves properly by being fair and impartial to all in carrying out their various duties. No official shall molest a competitor nor allow such practice by another official or other competitors. Should a competitor's equipment or demeanor warrant disqualification for an individual match or tournament, it should be done in such a manner as will cause the least inconvenience to all concerned. In so doing, the official should state to the competitor the rule or section of rules under which the disqualification is being made.

## **12. TEAM OFFICERS' DUTIES AND POSITION**

**12.1 Team Captain** - Each team must have a designated Team Captain. He is responsible for maintaining discipline within his team squad. He will at all times cooperate with the officials of the tournament in the interest of safety, efficiency and good sportsmanship. A Team Captain is responsible for all members of his team. It is his responsibility to:

- (a) Be familiar with the program.
- (b) Make proper entries.
- (c) Have team members report at proper firing point at the right time ready to fire.
- (d) Check scores, sign score cards and make challenges.
- (e) Check Preliminary and Official Bulletins and Official Notices.
- (f) Make protests.
- (g) Collect awards.

**12.2 Team Coach** - The Team Coach is the Team Captain's deputy performing such duties the Captain may assign to him. The coach serves as Team Captain in the absence of the latter, and under such circumstances becomes responsible for maintaining discipline within the team and for all other responsibilities of the Team Captain.

**12.3 Team Entries** - In team matches, the Team Officers, all firing members of the team, and alternate firing members (if allowed by the match conditions and provided by the team) must be named on the entry form before the first shot of the match is fired. If the Team Captain or Coach is also a firing member he must be so named. (See Rule 2.10)

**12.4 Substitution of Alternates** - If alternates are allowed and have been named on the entry form, the Team Captain may substitute an alternate for a firing member at any time before the firing member concerned has fired his first shot of the match (sighting or record), notifying the Scorer and the Range Officer accordingly. After a team member has fired his first shot, he may be substituted for only in case of disabling emergencies such as accident or illness, and then only if approved by the Chief Range Officer. All shots fired by the replaced shooter count; his replacement fires only the uncompleted portion of the replaced shooter's course of fire.

**12.5 Team Captain and Coach, Position** - In team matches, the Team Captain or Coach will be allowed on the firing line between and slightly to the rear of the shooter(s) in such a position as not to interfere with the proper operation of the range or with any member(s) of another team. He may not deliberately act as a sunshade or wind screen.

**12.6 Coaching in Team Matches** - Coaching is permitted in all team matches within the team only. The Coach may assist team members by calling shots, checking time, checking scoring, ordering sight changes, etc.; but he must so control his voice and actions as not to disturb other competitors. He will not physically assist in loading or making sight corrections.

**12.7 Checking Scores in Team Matches** - In team matches where targets are scored from a pit, it is permissible for Team Captain to have a team member, not then firing, placed in such position immediately behind the firing line that he can check the scores written on the score card by the scorer. An individual so placed shall not coach nor talk to the Coach, except regarding the scores posted to the score card.

## **13. PHYSICALLY DISABLED SHOOTERS**

**13.1 Physically Disabled Shooters** - A shooter who because of physical disability cannot fire from one or more of the prescribed shooting positions outlined in these Rules, or who must use special equipment when firing, is privileged to petition the NRA Protest Committee for permission to assume a special position or to use modified equipment, or both. This petition will be in the form of a written request from the person concerned to the Committee outlining in detail the reasons why the special positions must be assumed or the special equipment must be used. The petition will be accompanied by pictures of the shooter in the position he desires approved and, if special equipment is required, the picture will show how this equipment is used. The petition and all pictures must be furnished in exact duplicate. The petition must be accompanied by a medical doctor's statement if the physical disability is not completely evident in the pictures submitted.

- (a) Each petition will be reviewed by the NRA Protest Committee. The Committee may require additional or supplementary statements, medical information or pictures. If approved, the NRA Secretary will issue a special authorization certificate to the individual concerned. Such certificates will have necessary pictures attached.
- (b) Shooters who have received special authorization certificates will be required to carry them when competing in competition governed by NRA Rules, and to present the certificates when requested by officials of the competition or by NRA Official Referees.

- (c) In the event of a protest involving the position or the equipment used by such a shooter, the Official Referee or Jury will compare the questioned position or equipment with the certificate and photographs presented by the shooter. If the shooter's position or equipment does not, in the opinion of the officials, conform to that authorized by the NRA Secretary (or if the shooter has no authorized certificate or pictures), the protest shall be allowed and the shooter will be required to change immediately to the position or equipment which has been approved or to an otherwise legal position or equipment.
- (d) Should a protest be carried beyond the Official Referee or Jury, the original protest will be endorsed by the Referee or Jury Chairman to show the action he has taken and will be forwarded to the National Rifle Association.
- (e) National Records may not be established by use of scores fired in special positions or with special equipment as may be authorized according to the Rule.
- (f) Two types of authorizations are issued; temporary and permanent. Permanent authorizations are issued to competitors who are permanently disabled.

**13.2 Temporary Disability: Substitute Position** - Any person who has a temporary physical disability, as substantiated by a current written medical opinion, which prevents him from using a specified position as defined in this Rule, may assume the next more difficult position in lieu of that position. In this manner, sitting may be used for prone, kneeling may be used for sitting, and standing may be used for kneeling. Any substitute position must conform to the Rule which defines it. The Match Director must be informed of the substitute, and may require that the substitute position be demonstrated so he may be certain that it meets the definition of the appropriate Rule.

## 14. SCORING

**14.1 When to Score** - Usually targets are scored after each 10 shots in gallery matches, after each 20 shots in outdoor matches. Special conditions may require other than this usual procedure.

**14.2 Where to Score** - Targets may be scored in the Statistical Office or on the range in view of competitors and spectators. Scoring of targets while hanging, is prohibited. Whenever targets are scored where backing cards are used, the record target and backing card shall be compared.

**14.2.1 Targets as Score Cards** - Targets constitute the score cards when scored in Statistical Office and therefore must be retained in good order until the time allowed for filing challenges and protests has expired. See Rule 11.6.2

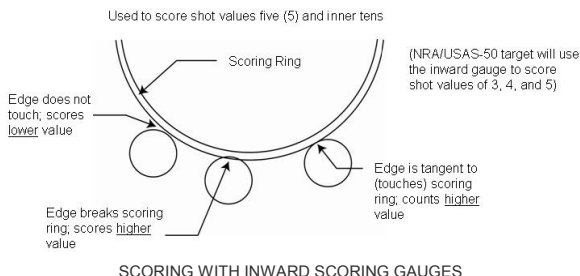

Used to score shot values ten (10) through six (6) (NRA/USAS-50)

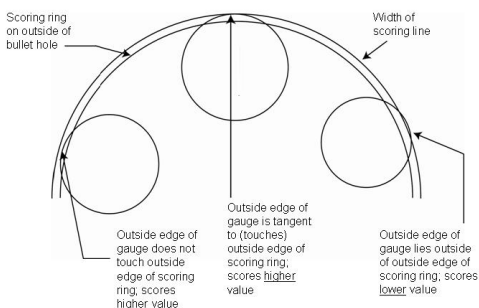

#### SCORING WITH OUTWARD SCORING GAUGES

- (a) Inward scoring is done as follows: The higher value will be allowed in cases where the flange on the gauge touches the scoring ring. Inward gauges must be within the following limits: .2225-.2240 inches (5.65 - 5.69 mm).
- (b) Outward scoring is done as follows: For all 10 dot shots the outward gauge (scoring away from the center) will be used to determine the value of close shot values 10 through 6. Outward gauges must be within the following limits: .3555 - .3535 inches (9.03 - 8.98 mm).
- (c) *X-ring* - The X-ring is the ring located inside the ten ring on targets A-23, A-25, A-26, and A-27. Any shot hole which touches the outside edge of the X-ring is counted as an X and used to break ties, rank scores and establish National Records in Outdoor Conventional Prone and Position shooting.
- (d) *Shot groups* - When, in scoring outdoor targets, the X, 10 and in some cases, the 9 rings are partially obliterated by shot groups of two or more shots or when two adjacent shot holes have a connecting tear in the target paper, the plug type scoring gauge shall not be used. In such cases, the values of the shots in the partially obliterated scoring ring area shall be determined by authorized tournament scoring personnel, and the Referee or jury when required, by using only the NRA Smallbore Rifle Scoring aid. The plastic overlay is **NOT** authorized for use in determining the value of single well defined shot holes. The use of this plastic overlay scoring aid supersedes any requirement for the use of a plug-type gauge under the conditions described.

*Note: Targets will be scored while in a horizontal position. The plug gauge should be inserted carefully so that no pressure is exerted to any side as this may affect the final plug position in the shot hole and, therefore, the value of the hit. Never plug a shot that is not doubtful.*

*If two scorers cannot agree on the value of a shot, another match official or jury member will decide.*

*To make tie breaking easier, it is suggested to score all X's, center shots, X's of higher value or center shots of higher value the first time the scoring team scores a target. Ties would be broken simply by comparing targets as opposed to re-scoring.*

- (e) X-ring shots of higher value - Those shot holes located within the X-ring as provided in Rule 14.3(b), whose outside leaded edge, as determined with the aid of an official .22 caliber scoring gauge or overlay, whose flange or outer ring does not touch the outside edge of the X-ring, are X-ring shots of higher value, and they are not used to establish National Records. (See Rule 15.7.1 (a) (4))
- (f) Center Shots - Those shot holes fired on targets without X-ring (A-7, A-17, A-32, A-33, A-50, and A-51) are used to break ties and rank scores (Center Shots are not scored on NRA/USAS-50 targets). Ties are broken starting with Rule 15.7.2 (b) Center shots are determined as follows:
  - (1) Indoor Conventional 50 ft. (A-17 target) - Any shot hole touching the ten ring but not touching the outside edge of the nine ring with the aid of a .22 caliber plug type scoring gauge. (Center shots are not used for the NRA USAS-50 target.)
  - (2) Indoor Conventional 75 ft. (A-7 target) - Any shot holes within the ten ring which, with the aid of a .22 caliber plug-type scoring gauge, the flange of which does not touch the outside edge of the ten ring.
  - (3) Outdoor NRA Metric Position and Metric Prone (A-50, A-51 targets) - Any shot hole(s) touching the inner ten ring.
  - (4) Outdoor Metric Prone (A-33 targets) - Any shot hole within the ten ring which, with the aid of a .22 caliber plug-type scoring gauge or overlay, the flange of which does not touch the outside edge of the ten ring.
  - (5) Light Rifle (A-32 target) - Any shot hole within the ten ring which, with the aid of a .22 caliber plug-type scoring gauge or overlay, the flange or outer ring of which does not touch the outside edge of the ten ring.
- (g) *Center shots of higher value* - All shot holes fired on the indoor conventional target (A-17 only) which, with the aid of a .22 caliber plug-type scoring gauge, obliterates the ten ring. They are used to break and rank ties of maximum center shot scores only (200-20), and will not be used to establish National Records.

**14.3.1 Authorized Use of Plug Type Scoring Gauges** - The use of the plug type gauge will be restricted to use by range operating personnel who may include the Range Officers or Block Officers, Statistical Officer, Match Director, Jury, or Referee, as appropriate to the type of tournament concerned. The tournament program should state in match conditions by whom and under what circumstances plug type scoring gauges may be used.

**14.4 Misses** - Hits outside the scoring rings of the competitor's target are scored as misses.

**14.5 Early or Late Shots** - If any shots are fired before the command **COMMENCE FIRE**, after the command **LOAD** has been given or immediately after the command **CEASE FIRE** prior to the command **THE LINE IS SAFE**, the shots of the highest value on the target card, equal in number to those fired in error, will be scored as misses. All shots fired before or after this time see Rule 9.30(h).

## 14.7 Excessive Hits

*Note: The term “target card” will be interpreted as applying to all record bullseyes framed at one time.*

- (a) *On his own target* - If a competitor fires more than the required number of shots on a target card, he will be scored only the required number of hits of lowest value minus a penalty of one point for each hit in excess of the required number on the individual bullseye(s) on which the excessive hits occur. Penalty points shall be deducted from the remaining hit or hits of highest value and the net value (actual value of hits less penalty) shall thereafter be scored as the actual value. A 10X or a 10 so penalized becomes a 9.

*If a competitor discovers that he has fired excessive shots on any bullseye(s), he should fire correspondingly fewer number of shots at succeeding bullseye(s) on the same target card. (Scorers see Rule 14.10 (a))*

- (b) *On the target of another competitor* - If a competitor fires more than the required number of shots for a target card and one or more hits are on a target other than his own, all shots on the targets of others will be brought back to the corresponding bullseye(s) on his own target and scored as outlined in Rule 14.7 (a) (excessive hits) and Rule 14.10 (cross-fires).

**14.8 Ricochets** - A hole made by a ricochet bullet does not count as a hit and will not be scored.

**14.9 Visible Hits and Close Groups** - All hits which are clearly visible on the target card will be scored. In the case where the grouping of three or more shots is such that it is possible for a required shot or shots to have gone through the enlarged hole without leaving a mark or marks, and there is no evidence that a shot or shots have gone elsewhere than through the assigned target (a cross-fire for example), the shooter will be given the benefit of the doubt and scored hits for the required number of shots in that bullseye. If such action could place a non-visible hit or hits in either of two scoring rings, such hits shall be scored in the high value ring. Backing cards, when used, should be reviewed by scoring personnel to assist in determining the number of shots creating the group in the affected bullseye.

### • 14.10 Hits on Wrong Target or Bullseye

*Note: The term “Target Card” will be interpreted as applying to all record bullseyes framed at one time.*

- (a) All cross-fires for metric and conventional smallbore competition, both external and internal cross-fires will be assessed one (1) penalty point. Shots fired onto another competitor's sighter bull are not penalized under this rule (See Rule 9.25). Penalty points shall be deducted from the remaining hit or hits of highest value and the net value (actual value of hits less penalty) shall thereafter be scored as the actual value.
- (b) A 10X or a 10 so penalized becomes a 9. If the actual hit(s) to be transferred cannot be established clearly, the hit(s) with the lowest value must be transferred to the bull with insufficient hit(s) so the shooter will gain no advantage in a tie-breaking situation.

- (c) Hits on wrong targets where backing cards are not used except electronic scoring targets. The competitor receiving a shot(s) claimed not to be his own will accept the value of the shot(s). If the additional shot(s) caused excessive hits, then the competitor will be scored the low hits minus one (1) penalty point for each excessive hit.

*See Rule 18.15(h) Responsibility.*

**14.11 Scoring Altered Targets** - Targets intentionally altered, or marked to benefit a shooter over other competitors, will not be scored. (See Rule 18.15 (f))

**14.12 Scoring Incorrect Targets** - Shots fired on incorrect targets will not be scored. Failure to hang a backer is not cause for penalty.

## 15. DECISION OF TIES

**15.1 Match** - The term “match” as used in this section refers to all individual, team and aggregate matches.

**15.2 Numbering of Bullseyes** - For the purpose of ranking tie scores, the bullseye numbers printed on NRA official targets will be considered to run in consecutive sequence throughout the entire course of fire, even though all targets for an event may not be framed at one time.

### 15.7.1 Tie Breaking for Prone Matches

#### (a) Fired Matches

- (1) By the greater number of X's over the entire course on targets with X-rings or center shots on targets without X-rings.
- (2) For the Dewar match, by the higher numerical score at the longer range, then by the greater number of X's or center shots at the longest range. If still a tie, then by the highest total score on each bullseye applied in reverse order from the last to first at the longest range. Repeat the procedure for the shorter range.
- (3) By the highest total score, including X's, on the last stage, if still tied, then the next stage in reverse order from last to first.
- (4) By the highest total score on each bullseye applied in reverse order from the last to first.
- (5) For targets with X-ring, (A-23, A-25, A-26, A-27), score the X-ring shots of higher value and apply 1 through 4 until the tie is broken (see Rule 14.3 (e)).

#### (b) Aggregate Matches

- (1) By the greater number of X's over the entire course on targets with X-rings or center shots on targets with X-rings.
- (2) By the total score of all 100 yard targets (A-25 or A-33).
- (3) By the greater number of X's or center shots at 100 yards.



- (4) By the highest total score on each bullseye applied in reverse order from last to first.
- (5) By the highest total score on each bullseye applied in reverse order from last to first on all 100 yard targets (A-25 or A-33).
- (6) If still a tie, repeat 2 through 4 on metric targets ( A-26 or A-27) for conventional prone, then on 50 yard targets (A-23) for conventional prone, (A-50 or A-51 for metric prone).

### 15.7.2 Tie Breaking for Position Matches

- (a) Fired match in a single position.
  - (1) By the greater number of X's over the entire course on targets with X-rings or center shots on targets without X-rings.
  - (2) By the highest total score, including X's, on the last stage. If still tied, then the next stage in reverse order from last to first.
  - (3) By the highest total score on each bullseye, including X's, applied in reverse order from last to first.
  - (4) For the 50 foot target (A-17), score the center shots of higher value and apply (1) and (2) until the tie is broken (Rule 14.3 (g)).
- (b) Aggregate Matches or any fired match consisting of multiple positions.
  - (1) By the greater number of X's over the entire course of targets with X-ring or center shots on targets without X-rings.
  - (2) By the highest total score, including X's, in the standing position, then kneeling and prone.
  - (3) By the highest total score, including X's on the last stage in the standing position. If still tied, then the next stage in reverse order from last to first. If still tied, use the same procedure in the kneeling position, then sitting, followed by prone.
  - (4) By the highest total score, including X's, on each bullseye applied in reverse order from the last to the first in standing. If still a tie, then use the same procedure in the kneeling, then sitting, and followed by prone.

**15.8 Team Matches** - Teams having the same total numerical score for the entire course of fire will be ranked by totaling the scores fired by all team members and ranking the score as though it had been fired by an individual for the same course of fire. Then use Rule 15.7 to break the tie.

**15.9 Matches Which Include Both Rifle and Pistol** - Competitors having the same total numerical score for the entire course of fire in matches which include both rifle and pistol stages will be ranked in order:

- (a) By the highest ranking score in the pistol stage.
- (b) By the highest ranking score in the rifle stage.

**15.10 Re-Entry Matches** - Competitors having the same numerical score will be ranked according to Rule 15.7 applied to the highest re-entry score.

**15.11 League Ties** - In leagues where team standing is determined by the percentage of matches won, ties will be decided as set forth in the league program.

**15.12 Ties for Selection to United States Team** - (Other than Postal) Competitors considered for selection to teams which will represent the United States having the same numerical score shall be ranked:

- (a) By the greatest number of X's over the entire course of fire, when X's are scored.
- (b) By a shoot-off with the course of fire determined by the Match Director.

**15.17 Unbreakable Ties** - In case a tie cannot be ranked as provided in this section, the Match Director will direct the awards to be given under one of the following plans:

- (a) By the firing of a complete or partial score under the original match conditions or at the longest range of the match.
- (b) In a slow fire individual match by firing of single shots at the longest range.
- (c) By drawing lots for merchandise, medal or trophy awards and pooling and equally dividing award points or cash awards to which those tied may be entitled.

## **16. CHALLENGES AND PROTESTS**

**16.1 Challenges** - When a competitor feels that a match fired by himself or by another competitor has been improperly evaluated or scored, he may challenge that score. Such a challenge must be made within the challenge time (*replugging or regauging is permissible*). It shall be the challenging competitor's privilege to inspect the target following the recheck.

- (a) A challenge fee not to exceed \$3.00 may be charged to all competitors making challenges. The challenge fee will be collected before making the first re-check of the challenged score. If the competitor's challenge is sustained at any point along the line of re-checks, the challenge fee will be returned to him. If the challenge is lost, the challenge fee will be included in the general revenue of the tournament. In NRA competition to which the NRA assigns a Referee, or where a Jury acts as a Referee, the decision of the Official Referee or Jury will be final (*replugging or regauging is permissible*).
- (b) The Match Director will, in all cases where an individual/team challenges the individual/team's targets not their own,

the individual/team's targets filing the challenge will also be re-scored.

- (c) The Match Director may at his discretion or by request, re-check any competitor's target by an administrative challenge. Such a challenge must be made before the end of the last posted challenge period of the tournament and checked by the Referee or Jury. For further information of the Statistical Office operation, see Rules 11.6 through 11.6.8 inclusive.
- (d) It shall be the responsibility of the Tournament Sponsor to state in the program or by Special Bulletin Board notice the time limits within which a challenge may be made.
- (e) When targets are scored in the Statistical Office or on display racks, the re-check will be made by the Chief Statistical Officer (provided he has not previously scored or checked the target) or the Official Referee or Jury in that order.
- (f) Fired matches are challenged by total score, not individual shots, targets or stages.
- (g) Aggregate matches when challenged, only correct the addition of all fired matches.

**16.2 Protests** - A competitor may formally protest:

- (a) Any injustice which he feels has been done him except the evaluation of a target, which he may challenge as outlined in Rule 16.1.
- (b) Conditions under which another competitor has been permitted to fire.
- (c) Equipment which another competitor has been permitted to use.

**16.2.1 Authority of Protest Committees** - National Championships protest committees or juries may be established at National Championships to rule on protests arising from activities at those sites. (See Rule 11.8) However, the decisions of these special protest committees or juries shall not contravene prior interpretations of the NRA Rules and/or precedents established by the NRA National Protest Committee.

**16.3 How to Protest** - A protest must be initiated immediately upon the occurrence of the protested incident. Failure to comply with the following procedure will automatically void the protest:

- (a) State the complaint orally to the Chief Range or Chief Statistical Officer. If not satisfied with his decision then,
- (b) State the complaint orally to the Official Referee or Jury Chairman. If not satisfied with his decision then,
- (c) File a formal protest in writing with the Official Referee or Jury Chairman stating all the facts in the case. Such written protest must be filed within 12 hours of the occurrence of the protested incident.
- (d) The Official Referee or Jury Chairman will then forward the protest with a complete statement of facts within 48 hours of receipt thereof to the Protest Committee at NRA Headquarters.

## 16.4 Challenges and Protests in Team Matches

- (a) Must be made by the Team Captain. Team members who believe they have reason to challenge or protest will state the facts to their Team Captain who will make the official challenge or protest if he feels such action is justified.
- (b) It shall be the responsibility of tournament sponsors to state in the program or by Special Bulletin Board notice that team challenge fees shall be either:
  - (1) Not to exceed \$3.00 per team score.
  - (2) Not to exceed \$3.00 per team member's score.

## 17. NATIONAL RECORDS

*NRA National Records shall be established only by American Citizens who are NRA members or Junior members of NRA affiliated clubs.*

*National Records may be established only when competition exists, i.e.; more than one competitor or team in an event.*

**17.1 Where Scores for National Records can be Fired** - Scores to be recognized as National Records must be fired in NRA Registered Competition as defined in Rule 1.6, paragraphs (c), (d), (e) and (f). National Records must be approved by the NRA before being declared official. National Records may not be established during reentry matches or outdoor matches using artificial illumination.

**17.2 Scores to be Used** - Scores must be complete for an entire scheduled match. Stage scores or scores for only part of a match will not be used for Records. Scores fired over 50 feet or 75 feet will be considered for the establishment of National Records, whichever is higher. Outdoor mid-range scores must not be fired under artificial light. Scores fired in any sight matches will be eligible for any sight records only.

• **17.3 Scores for National Individual Records** - Such scores must be fired in individual matches. No score fired in a team match will be considered for recognition as an individual record. For recognition as special group records, (Open, Women, Senior, Junior, Intermediate Junior, and Sub-Junior) scores may be fired in either open or restricted matches. All targets to be considered for National Records must be sent to NRA Headquarters Competitions Division for verification.

• **17.4 Scores for National Team Records** - Such scores must be fired in matches where teams fire as a unit and no combination of individual match scores will be considered for recognition as a team record (except Metric Position Sectional Teams). For recognition as special group Records (Open, Women, and Junior categories) all members of the team must be members of the special group concerned (Rule 1.7(d)). Teams must be bona fide teams as outlined in Rules 2.11 to 2.18. National Records will not be recognized for pickup teams (teams made up of shooters who do not represent one of the groups outlined in Rules 2.11 to 2.18.) All targets to be considered for National Records must be sent to NRA Headquarters Competitions Division for verification.

## • 17.5 Course of Fire for Which National Records are Recognized

*Note: National Smallbore Rifle Records are maintained for scores fired with Metallic and with Any Sights over the following courses for Open, Women, Senior, Junior, Intermediate Junior, and Sub-Junior categories. (See Rule 8.2 for time allowances.)*

In order for Records to be recognized promptly, National Record Reporting forms must be submitted to NRA by the Statistical Officer of the tournament in which they were fired, after being certified by the Jury or Referee. National Record Reporting forms are mailed to the sponsors of NRA Registered Tournaments by NRA Headquarters.

- (a) Individual Conventional Prone
  - (1) Dewar Course, 20 shots at 50 yards A-23 target; 20 shots at 100 yards, A-25 target.
  - (2) 40 shots at 50 yards, A-23 target
  - (3) 40 shots at 50 meters, A-26 target or 40 shots at 50 yards, A-27 target
  - (4) 40 shots at 100 yards, A-25 target
  - (5) Aggregate of the above four matches (1600)
  - (6) Aggregate of the combined metallic and any sight aggregates of the above four matches (3200)
  - (7) Aggregate of twice over the above four matches (3200)
  - (8) The aggregate of 6400 points comprised of four times over the 40 shot 50 yard, 50 meter, 100 yard and Dewar Course, twice over these courses with metallic sights and twice over the same courses with any sights
  - (9) Aggregate of 1200 comprised of the combined 50 meter match (40 shots, A-26 Target), Dewar Course (20 shots, A-23 target and 100 yard match 20 shots, A-25 target).
  - (10) Aggregate of the combined metallic and any sight aggregates of the 1200 aggregates for a 2400.
  - (11) The aggregate of 4800 points comprised of four times over the 40 shot 50 meter, Dewar Course and 100 yard, twice over these courses with metallic sights and twice over with any sights.
- (b) Two or Four Man Teams, Conventional Prone, fired by each member:
  - (1) Dewar Course, 20 shots 50 yards, A-23 target, and 20 shots 100 yards, A-25 target
  - (2) 40 shots at 100 yards, A-25 target
  - (3) 40 shots at 50 meters, A-26 target; or 50 yards, A-27 target

- (c) Individual Conventional Position (50 yards, A-23 target):
- (1) 10 shots in each of the four positions, Prone, Sitting, Kneeling and Standing, A-23 target
  - (2) 20 shots in each of the four positions, Prone, Sitting, Kneeling and Standing, A-23 target
  - (3) 20shots in each of the three positions, Prone, Standing and Kneeling
  - (4) An aggregate of twice the 80 shot Conventional 4-Position match
  - (5) An aggregate of twice the 60 shot Conventional 3-Position match
  - (6) 20 shots Sitting
  - (7) 20 shots Kneeling
  - (8) 40 shots Kneeling
  - (9) 20 shots Standing
  - (10) 40 shots Standing
  - (11) The Grand Aggregate of 1600 points which is a combination of the 800 point position metallic sight aggregate and the any sight 800 point position aggregate.
  - (12) The Grand Aggregate of 3200 points which is a combination of the 1600 point position metallic sight aggregate and the any sight 1600 any sight aggregate.
- (d) Two or Four Man Teams, Conventional 4-Position:
- (1) 10 shots at 50 yards in each position, Prone, Sitting, Kneeling and Standing, A-23 target
  - (2) 20 shots at 50 yards in each position, Prone, Sitting, Kneeling and Standing, A-23 target
- (e) Individual Conventional 4-Position Indoor: (Course may be fired at 50 feet on the A-17 target, or at 75 feet on the A-7/5 or A-7/10 targets.)
- (1) 20 shots Sitting
  - (2) 20 shots Kneeling
  - (3) 40 shots Kneeling
  - (4) 20 shots Standing
  - (5) 40 shots Standing
  - (6) 10 shots in each of the four positions, Prone, Sitting, Kneeling and Standing
  - (7) The Open Sectional Aggregate Course
  - (8) 20 shots in each of the Conventional 3-Position, Prone, Standing and Kneeling

- (9) 40 shots in each of the Conventional 3-Position, Prone, Standing and Kneeling
  - (10) Grand Aggregate of 1600 points which is a combination of the 800 point position metallic sight aggregate and the 800 point position any sight aggregate
- (f) Two or Four Man Teams, Conventional Indoor Four Position to be fired by each team member:
- (1) 10 shots each of the four positions, Prone, Sitting, Kneeling and Standing on the A-17, or A-7/5, A-7/10 (75 feet) targets
- (g) Outdoor Metric Prone Courses:
- (1) 20 shots at 50 yards, A-51 target or 50 meters, A-50 target and 20 shots 100 yards, A-33 target (Metric Dewar Course)
  - (2) 40 shots at 50 yards, A-51 target or 40 shots at 50 meters, A-50 target
  - (2a) 60 shots at 50 yards, A-51 target or 60 shots at 50 meters, A-50 target
  - (3) 40 shots at 100 yards, A-33 target
  - (4) Aggregate of 1200 comprised of once over matches #1, #2, #3, either iron or any sights
  - (5) Aggregate of 1600 comprised of twice over the Dewar Course, (#1), once over the 50 yard/50 meter course, (#2), and once over the 100 yard course, (#3) either with metallic or any sights
  - (6) Aggregate of 2400, combination of twice over the 1200 course (#4) either with metallic or any sights
  - (7) Aggregate of 2400, combination of twice over the 1200 course, (#4), once with metallic sights and once with any sights
  - (8) Aggregate of 3200, combination of twice over the 1600 course (#5) either with metallic or any sight
  - (9) Aggregate of 3200, combination of twice over the 1600 course, (#5), once with metallic sights and once with any sights
  - (10) Aggregate of 4800, combination of twice over the 2400 course, (#6), once with metallic sights and once with any sights
  - (11) Aggregate of 6400, combination of twice over the 3200 course, (#7), once with metallic sights and once with any sights.
  - (12) 15 shots at 100 yards, A-37 target
  - (13) 15 shots at 100 yards, A-38 target
  - (14) 15 shots at 100 yards, A-39 target
  - (15) Aggregate of 450 of (12), (13) & (14)

(h) Outdoor Metric Prone Team Courses Two and Four Man Teams - The following course to be fired by each member:

- (1) 20 shots at 50 yards/50 meters and 20 shots at 100 yards (17.5(g)(1))
- (2) 40 shots at 100 yards (17.5(g)(3))
- (3) 40 shots at 50 yards/50 meters (17.5(g)(2))
- (4) 15 shots at 100 yards (17.5(g)(12))  
15 shots at 100 yards (17.5(g)(13))  
15 shots at 100 yards (17.5(g)(14))

(i) NRA Metric Position Individual Courses

The following Records apply to NRA Metric Position Course matches with the exception that no Prone Records will be maintained at 50 feet. Indoor Records will be on the NRA/USAS-50, indoor/outdoor Records on the A-50 or A-51 targets. Each target must be fired at its stated distance.

Individual:

- (1) 40 shots Prone (see note)
- (2) 60 shots Prone. May be shot as a single match or an aggregate of No. 1 plus a 20-shot Prone match
- (3) 20 shots Kneeling
- (4) 40 shots Kneeling
- (5) 20 shots Standing
- (6) 40 shots Standing
- (7) 60 shots Prone, Kneeling and Standing (20 shots each)
- (8) 120 shots, may be fired as a single match, an aggregate of matches 1, 4, 6 or an aggregate of two times match 7 (same sights)
- (9) 240 shots aggregate (120 shots metallic sights and 120 shots any sights, each may be composed as in match 8)

*Note: 40 shot Prone Record at 50 meters/50 yards on A-50/A-51 targets will be maintained under 17.5 (g) Outdoor Metric Prone Course #2.*

(j) NRA Metric Position Team Courses Two and Four Man Teams - The following course to be fired by each member: (except Metric Position Sectionals)

- (1) 30 shots Prone, Kneeling and Standing (10 shots each)
- (2) 60 shots Prone, Kneeling and Standing (20 shots each)
- (3) 120 shots Prone, Kneeling and Standing (40 shots each)

(k) Light Rifle Prone 30 shots (50 yards)



- (l) Light Rifle 3-Position, 10 shots in each of the three positions, Prone, Kneeling and Standing (50 feet or 50 yards)
- (m) Light Rifle Standing, 20, 30, 40, 60, 80, 100 shots Standing (50 feet or 50 yards)

**17.6 Co-holder Records** - Tie breaking rules beyond the use of numerical scores including X count will not be employed when establishing National Records. Co-holder status will be accorded to individuals or teams when their score equals a National Record.

## **18. COMPETITORS' DUTIES AND RESPONSIBILITIES**

*Note: The following competitors' duties are in addition to those specified elsewhere throughout these Rules.*

**18.1 Discipline** - It is the duty of each competitor to sincerely cooperate with Tournament Officials in the effort to conduct a safe, efficient tournament. Competitors are expected to promptly call the attention of proper officials to any infraction of rules of safety or good sportsmanship. Failure of a competitor to cooperate in such matters or to give testimony when called upon to do so may result in said competitor being considered as an accessory to the offense.

**18.2 Knowledge of Program** - It is the competitor's responsibility to be familiar with the program. Officials cannot be held responsible for a competitor's failure to obtain and familiarize himself with the program.

**18.3 Eligibility** - It is the competitor's duty to enter only those events for which he is eligible and to enter himself in the proper classification.

**18.4 Classification** - It is the competitor's duty to have his current classification card in his possession when competing in competition using a classification system. Unclassified competitors may obtain their Score Record Books from the Official Referee or Tournament Officials.

**18.5 Individual Entries** - In individual matches it is the duty of the competitor to make his own entries on the forms and in the manner prescribed for that tournament. Errors due to illegibility or improper filling out of the forms are solely the competitor's responsibility. The Statistical Office is not required to accept corrections after the entry closing time.

**18.6 Squadding Tickets** - It is the duty of the competitor to secure his squadding ticket for each match (or to consult the squadding bulletin) in ample time to permit reporting at the proper time and place to fire each match. It is not the duty of officials to page competitors in order to get them on the firing line. Competitors upon receipt of squadding tickets should inspect them for correctness of competitor's number and non-interference in squadding assignment. Errors should be immediately reported to Statistical Officer.

**18.7 Reporting at Firing Point** - Competitors must report at their assigned firing point immediately when the relay is called by the Range Officer. The proper rifle and ammunition for that particular match must be ready and in safe firing condition. Time will not be allowed for rifle repairs, sight blacking, sight adjustments or search for missing equipment after a relay has been called to the firing line. (See Rule 10.3)

**18.8 Timing** - The timing of the firing of a stage (within the official time limit) is the competitor's responsibility. Range Officers will not announce the time during the firing but if requested will give the competitor information as to remaining time.

**18.9 Loading** - No competitor will load a rifle except at the firing point and after command has been given by the Range Officer.

**18.10 Cease Firing** - All rifles will be unloaded immediately upon the command **CEASE FIRING – UNLOAD AND INSERT ECI**. Actions will remain open with the ECI inserted.

**18.11 Checking Scores** - It is the duty of competitors to check the Preliminary Bulletin Board and call attention to errors within the time specified at that tournament. Failure to check scores within the time limit forfeits the right to challenge.

**18.12 Clearing the Firing Point** - It is the competitor's duty to leave the firing point promptly at the conclusion of his relay. When leaving the firing point the rifle must be unloaded with action open and ECI inserted.

**18.13 Checking Bulletin Board** - It is the duty of all individual competitors and Team Captains to check the Bulletin Board between each match. The Statistical Officer must be immediately notified of apparent errors. Official Bulletins must be checked and the Statistical Officer notified of any discrepancies between the Preliminary and Official Bulletins. Match Director's Bulletins on the Bulletin Board have the same effect as conditions printed in the program. It is the duty of competitors to familiarize themselves with all such Official Notices.

**18.14 Score Cards Must be Signed** - When targets are scored on the firing line or at the target butts at the conclusion of the scoring, the scorer adds the value of the shots, places the total on the score card and signs the card.

**The competitor checks the value of the individual shots, the total, and signs the card.** Team Captains verify and sign score cards in team matches. If a competitor or Team Captain leaves the target or firing line without signing the card, no challenge will be allowed. If the competitor or Team Captain desires to protest, he shall write "protested" on the score card above his signature.

• **18.15 Responsibility** - It shall be the competitor's responsibility, that:

- (a) All equipment meets all rules and match specifications in any match in which that equipment is to be used.
- (b) Competitor's position conforms to the rules.
- (c) Competitor has full knowledge of the rules under which that match is fired.
- (d) After due warning of any infraction of existing rules, including the improper marking of the target, that competitor shall understand that a repetition thereof shall be the subject of disqualification for that match or tournament. (See Rule 9.30)
- (e) When targets are framed by the competitor, it is the competitor's responsibility that the correct target and backer for the range and position being fired are framed properly. (Rule 14.12)

- (f) To ensure that his target is not altered intentionally or with special marks which benefit him in any way. Scores fired on such targets will be disqualified. (See Rule 14.11)
- (g) When the targets are framed by the competitor, it is the competitor's responsibility to ensure that the area between the target and firing point is clear of obstructions (weeds, wind flags, etc.) before the start of the three (3) minute preparation period.
- (h) If the competitor knows that he or she has fired or receives a cross-fire, he or she will notify the Range Officer who will make a note of the cross-fires on the targets, above the lines to facilitate scoring of the targets.

## **19. NATIONAL SMALLBORE RIFLE CLASSIFICATION**

**19.1 Classified Competitors** - Individuals who are officially classified by the NRA for smallbore competition, or who have a record of scores fired over the courses of fire used for classification (see Rule 19.4) which have been recorded in a Score Record Book.

**19.2 Unclassified Competitor** - A competitor who does not have a current NRA Smallbore Rifle Classification, either regular or temporary by Score Record Book (Rule 19.14), nor an Assigned Classification (Rule 19.6). Such competitor shall compete in the Master Class.

**19.3 Tyro Competitors** - Competitors who have not previously fired in organized, civilian, police or military smallbore rifle competitions, regardless of the course of fire composing such matches. Any tournament sponsor may include in their program a prize schedule of award(s) for the Tyro Class.

• **19.4 Scores Used for Individual Classifications** - Scores to be used for classification and reclassification will be those fired in matches in NRA Competition as defined in Rule 1.6 (except Postal Matches) over the following courses of fire and under the indicated conditions:

Outdoor Conventional Prone Classification:

Dewar Course (50 and 100 yard) (A-23, A-25)  
 50 Yards (A-23)  
 50 Meters (A-26 or A-27)  
 100 Yards (A-25)

Outdoor Metric Prone Classification:

Dewar Course (50 yards or 50 meters and 100 yards)  
 (A-51, A-50 and A-33 target)  
 50 Yards or 50 Meters (A-51 or A-50 target)  
 100 Yards (A-33 target)  
 100 Yards (A-33, A-37, A-38, A-39)

NRA Metric Position Course Classification:

Indoor or outdoor, Prone, Kneeling and Standing, 50 feet or 50 yards/50 meters, NRA/USAS-50 target or A-51/A-50 target

Conventional Position Course Classification:

Indoor or outdoor, Prone, Sitting, Kneeling and Standing, 50 feet or 50 yards, A-17 target or A-23 target

Both metallic and any sight match scores will be used. Matches may be fired outdoors or indoors. Scores fired indoors over outdoor courses will not be used for outdoor classification. Scores from Sanctioned Leagues (shoulder-to-shoulder or postal) may be used during the league firing season in Score Record Books (19.14) but will be used by NRA Headquarters only at the end of the league firing season for issue of official classification cards.

#### **19.4.1 Expanded Classification System for Juniors (Rule 2.3)**

**Only** - A match sponsor may use an expanded or different classification system for junior shooters. Within that system, coaching may be allowed by the sponsor. However, the scores fired in classes that allow coaching will not be used for national records or national standing, but shall be reported for NRA classification purposes.

**19.5 Compilation of Scores for Classification Averages** - Scores fired in complete matches over the above Outdoor Conventional Prone Courses will be combined for the Outdoor Conventional Prone Classification. Scores fired in complete matches over the above Outdoor Position Courses will be combined for the Outdoor Position Classification and scores fired in complete matches over the above Indoor Courses will be combined for the Indoor Classification. Scores fired in complete matches over the above Outdoor Metric Prone courses will be combined for the Outdoor Metric Prone Classification. Shots fired without receiving a score will not be used for classification purposes. A cross-fire or disqualified stage or match would not be used for classification purposes.

*For classification purposes - Any cross-fires for misses or disqualifications of a competitor's score should have the corresponding number of shots removed from the "shots fired" part of the SR-1 card, and send in the scores as fired.*

*e.g., - A competitor fires six external cross-fires in standing or metric prone. Reduce the number of shots fired by 6, such as 114 instead of 120 in Metric Position or 154 instead of 160 for metric prone.*

*e.g., - A competitor hangs a target upside down or hangs an incorrect target, and the stage is disallowed (Rules 14.11, 14.12, 18.15 (f)). Remove 20 shots from the shots fired total.*

*Any act done by a competitor on purpose or unintentionally, that causes him to lose a shot(s), should have the corresponding number of shots reduced from his "shots fired" figure in order to allow that competitor to receive the classification he earned by all the correctly fired shots.*

**19.6 Assigned Classification** - A competitor who has an earned classification (a classification obtained through his Score Record Book or an Official NRA Classification Card) for one type of competition in the grouping listed below will be assigned this same classification in any competition in which he does not already have an earned or assigned classification. If he has a classification in more than one type in the list below, he shall use the higher classification. After his first tournament in the new type, he will use his Score Record Book rather than his assigned classification when entering his second tournament in the new type.

Smallbore and High Power Rifle:

- (a) Indoor Conventional Position
- (b) Outdoor Convention Position Smallbore Rifle
- (c) Indoor NRA Metric Position
- (g) High Power
- (h) 300 Meter

- (d) Outdoor NRA Metric Position Rifle    (i) Air Rifle
- (e) Outdoor Metric Prone
- (f) Outdoor Conventional Rifle Prone

**19.7 Lack of Classification Evidence** - It is the competitor's responsibility to have his NRA Official Classification Card or Score Record Book with required scores for temporary classification (see Rules 19.1 and 19.14) and to present such classification evidence when required. Any competitor who cannot present such evidence will fire in the Master Class. A competitor's classification will not change during a tournament. A competitor will enter a tournament under his correct classification and fire the entire tournament in that class. Should it be discovered during a tournament that a competitor has entered in a classification lower than his current rating, the tournament records will be corrected to show the correct classification for the entire tournament.

**19.8 Competing in a Higher Class** - Any individual or team may elect, before firing, to compete in a higher classification than the one in which classified. Such individual or team must fire in such higher class throughout the tournament and not revert to earned classification for any event in that tournament.

**19.8.1 Combining Classes** - When there are insufficient entries in any class to warrant an award in that class according to the match program conditions, the individual or team concerned may be moved by the Tournament Match Director to a higher class provided this change is made prior to the individual or team concerned having commenced firing in the tournament.

**19.9 Obsolete Classifications and Scores** - All classifications and scores (including temporary, Rule 19.14) except Master, shall become obsolete if the competitor does not fire in NRA competition at least once during three successive calendar years. Master classifications and scores shall become obsolete if the competitor does not fire in NRA competition at least once during five successive calendar years. Lifetime Master classifications will not become obsolete.

**19.10 Appeals** - Any competitor having reason to believe that he is improperly classified may file an appeal with the NRA stating all essential facts. Such appeals will be reviewed by the NRA Protest Committee.

**19.11 Protests** - Any person who believes that another competitor has been improperly classified may file a protest with the NRA stating all essential facts. Such protests will be reviewed by the NRA Protest Committee.

**19.12 Team Classification** - Teams are classified by computing the team average based on the classification of each firing member of the team. To compute this team average the key in Table No. 1 for the different classes will be used for both outdoor and indoor competition and the team total divided by the number of firing members of the team. Any fractional figure in the team average of one half or more places the team in the next higher class. The team average will establish classification of the team as a unit but will not affect in anyway the individual classification of team members.

**TABLE 1 - OUTDOOR AND INDOOR**

<b>Class</b>	<b>Key</b>	<b>Class</b>	<b>Key</b>
Master .....	4	Sharpshooter .....	2
Expert.....	3	Marksman .....	1

**19.13 Reporting Scores** - NRA indoor and outdoor competition (see Rule 1.6) sponsors must report to the NRA all individual and fired team match scores fired over the courses stated in Rule 19.4. Scores fired in individual matches must be reported as aggregate totals, and scores from fired team matches must be reported as separate aggregate totals. Scores from all tournament and sanctioned leagues must be reported by each sponsor no more than 30 days upon completion of the tournament firing schedule.

**19.14 Score Record Book (Temporary Classification)** - A Score Record Book will be obtained by each unclassified competitor from the Official Referee or tournament Statistical Office at the time the competitor competes in his first tournament or from the Secretary of a sanctioned league. He will record all scores fired by himself in all NRA competition (except Postal Matches) until such time as he receives his official NRA classification card. The competitor will total all scores and divide that total by the number of 10 shot strings represented. The average so obtained will determine the competitor's NRA classification at that time (see Rule 19.15 for average score for each classification).

Individual and team scores fired by the competitor during at least one tournament (Rule 1.1) or from the most recent league match (Rule 1.6) must be posted in the Score Record Book to establish a temporary classification. The Score Record Book will be presented by the holder at all NRA competitions entered until the competitor's Official NRA Classification Card becomes effective.

*Note: It is the competitor's responsibility to obtain the Score Record Book, enter scores and present it at each tournament until his Official NRA Classification Card becomes effective. When the NRA Classification Card becomes effective, the Score Record Book becomes obsolete.*

**19.15 Individual Class Averages** - Competitors will be classified as follows and NRA Classification Cards issued accordingly:

**TABLE 2 - INDIVIDUAL**

- (a) Outdoor Conventional Prone - 200 shots minimum required for classification.

Master .....	99.50 and above
Expert.....	98.50 to 99.49
Sharpshooter .....	96.50 to 98.49
Marksman .....	Below 96.50

- (b) Outdoor Metric Prone - 200 shots minimum required for classification

Master .....	94.50 and above
Expert.....	92.00 to 94.49
Sharpshooter .....	89.50 to 91.99
Marksman .....	Below 89.50

- (c) Conventional Position - 160 shots required for classification

Outdoor

Master .....	97.00 and above
Expert.....	94.00 to 96.99
Sharpshooter .....	91.00 to 93.99
Marksman .....	Below 91.00

Indoor	
Master .....	98.00 and above
Expert.....	96.50 to 97.99
Sharpshooter .....	93.00 to 96.49
Marksman .....	93.00

(d) NRA Metric Position - 120 shots minimum required for classification

Indoor	
Master .....	92.00 and above
Expert.....	89.00 to 91.99
Sharpshooter .....	86.00 to 88.99
Marksman .....	Below 86.00

Outdoor	
Master .....	89.00 and above
Expert.....	86.00 to 88.99
Sharpshooter .....	83.00 to 85.99
Marksman .....	Below 83.00

**19.16 Establishing Classification** - Classification or reclassification average will be based on average scores reported for 10 shot strings, computed only after the total scores for tournaments, or a league season have been posted and, therefore, the average may be based on a number of shots greater than the required minimum number as specified. When the scores for the required minimum number of shots (or more if the minimum is reached during a tournament, or league season) have been posted, the average score per 10 shot string will be computed. The competitor will then be sent an Official NRA Classification Card based on the average so computed and according to the tables for the specific type of competition concerned. This classification will become effective the date shown on the card issued by NRA.

### 19.17 Reclassification

(a) A competitor who has been classified by the NRA will be reclassified upward when his average, as computed below, places him in a higher class. The scores used for reclassification will be his recently recorded NRA competition scores as maintained at NRA Headquarters fired subsequent to the tournament date at which he earned his current classification. The average will be computed when the scores for the minimum number of shots for reclassification (or more if the minimum is reached during the scores of any tournament or league) have been posted. The competitor will be sent a new Classification Card showing the effective date.

(b) Minimum posted shots required for upward classification:

(1) Outdoor Conventional and Metric Prone  
Reclassified to:

Sharpshooter.....	400
Expert.....	400
Master.....	700

(See table in Rule 19.15 for percentages)

(2) Outdoor and Indoor Conventional Position  
Reclassified to:

Sharpshooter.....	160
Expert.....	320
Master.....	320

(See table in Rule 19.15 for percentages)

- (3) NRA Metric Position Indoor and Outdoor  
Reclassified to:

Sharpshooter.....	120
Expert.....	240
Master.....	360

(See table in Rule 19.15 for percentages)

- (c) A competitor who believes his classification is too high (Lifetime Masters see Rule 19.21) may file a written request with the NRA that his classification be lowered. Such competitor must remain in the class concerned until at least the following have been posted to his record. (These shots must be fired after the effective date of his current classification):

Outdoor Conventional or Metric Prone Reclassification - 1200 Record Shots.

Outdoor or Indoor Conventional Position Reclassification - 960 Record Shots.

NRA Metric Position Reclassification - 960 Record Shots.

When the average of such shots places the competitor in a lower class he will be reclassified accordingly.

**19.21 Lifetime Master** - Competitors who have been certified as Lifetime Masters will retain their Lifetime Master cards and enter competitions in the Master Class, except that,

- (a) No new Lifetime Masters will be certified.
- (b) Lifetime Masters will be reclassified to a higher class, according to the provisions of Rule 19.17(b) and must enter competitions in the higher class. (Does not pertain to smallbore rifle competition at this time.)
- (c) Lifetime Masters may petition NRA to revoke a Lifetime Master card and be reclassified downward according to the provisions of Rule 19.17(c).

## 20. NRA OFFICIAL REFEREE

**20.1 Eligibility** - Any individual, 21 years of age or older, who fulfills the requirements currently in effect may be certified as an Official Referee.

### 20.2 Certification

- (a) To be certified as an Official Referee, applicants must undertake such oral, written or practical examinations as the Association may require.

*Note: The Board of Directors of the Association may be the final judge as to the applicant's fitness for certification. Certification may be refused without stating a cause.*

- (b) Certificates will remain in force for such periods as may be indicated on the face thereof. Certificates may be surrendered by the holder or canceled by the Association at any time without stating a cause.



- (c) Re-examination may be required at any time to determine the Official Referee's current ability to meet the requirements.
- (d) Official Referees may be authorized to serve with certain limitations specified in their authorization. Such limitation may be:
  - (1) For a limited time only, or
  - (2) For a special tournament or tournaments, or
  - (3) Within specified territorial boundaries, or
  - (4) For specified types of competition or classes of tournaments.
- (e) Insignia remains the property of the Association and must be returned at the termination of the Official Referee's certification.

### **20.3 Duties - General**

- (a) It is the duty of the Official Referee at all times to keep informed of NRA Bylaws, current competitive rules, and match administrative procedures and be equipped to act as a guide and counselor to every official at a tournament both on the range and in the Statistical Office.
- (b) He must be familiar with the various NRA qualification courses and with the National Classification Rules.
- (c) He must know the requirements for individual membership in the Association and the general requirements for club affiliation.
- (d) It is his duty to report to NRA Headquarters any suggestion, criticism, incidents or trends which, in his opinion, should be considered by the Association in order to promote the best interest of shooting.
- (e) He must at all times and under all circumstances remember that the value as an Official Referee is in direct relation to his integrity, impartiality, broad knowledge of the game, courtesy, courage and sobriety. The use of alcoholic beverages while on duty will not be condoned, and its excessive use at any time will be sufficient cause for cancellation of the Official Referee's certificate.

**20.4 Duties - Before Tournament** - Having accepted an assignment to serve, it is the duty of the Official Referee to:

- (a) Familiarize himself with the program.
- (b) Verify, by mail or in person, with the Match Director of the tournament that the range and statistical facilities are adequate and in good order and that ample range and statistical personnel have been employed or definitely arranged for.

### **20.5 Duties - During Tournament**

- (a) Observe the functioning of the Statistic Office when first opened to help establish proper registration and squadding procedures. Make sure the Statistical Office has arranged to verify each competitor's current classification before issuing competitors' first squadding tickets.

- (b) Inspect target equipment and range personnel in company with the Match Director to ensure that the range will function properly.
- (c) Consult with the Match Director and arrange to have Official Bulletins posted immediately covering any authorized changes or corrections.
- (d) Personally observe the scoring and bulletin methods used when targets for the first relay are being scored and call attention to any errors before a faulty method becomes established.
- (e) Remain constantly alert for infractions of safety or competition rules by moving over the range behind the firing line from flank to flank; observing the activities of Range Officers, target runners, scorers, statistical clerks, and spectators, watching competitors handling rifles, and so forth.
- (f) Report immediately to the Match Director any errors in administration or infractions of these rules by competitors or tournament operating personnel, requesting that they be corrected at once. If the matter is one requiring instant action, the Official Referee should direct whatever action is required and report actions and reasons therefore to the Match Director as soon as that official can be reached.
- (g) In tournaments when situations occur that are not specifically covered by an existing rule or rules, the Referee shall exercise his best judgement in ruling for the best interest of safety, the shooting sports and competitors.
- (h) Personally consult with the Statistical Officer at the conclusion of the tournament to make sure that all bulletins have been properly completed and awards issued as prescribed in the Tournament Program.
- (i) Forward to NRA Headquarters all reports that may be required, including copies of National Record Reporting Forms (see Rule 17.4), protests, decisions, appeals, and all written statements bearing on the case.
- (j) If triggers are weighed, weigh, or supervise the weighing of, triggers.

**20.6 Handling of Challenges and Protests** - Challenges and protests will be handled in the manner provided for in these Rules.

**20.7 Assignment to Tournaments** - Official Referees are assigned to tournaments by NRA Headquarters.

**20.8 Official Referee as Competitor** - No Official Referee may compete in any match fired in conjunction with any tournament where he is officiating.

### **20.9 Status of the NRA Official Referee**

- (a) The Official Referee will not give directions to the tournament operating personnel except through the Match Director. In all emergency cases involving the safety of personnel or property the Official Referee will act immediately and forcefully, taking full responsibility and reporting his action thereafter to the Match Director and to the National Rifle Association when making his tournament report. In the event of a disagreement between Match Officials, the Official Referee shall prevail at the match with recourse only to the Protest Committee.

- (b) The Official Referee is a representative of the National Rifle Association and is present at a tournament to interpret the rules and regulations for the benefit of both the Tournament Officials and the competitors. It is the Referee's duty to see that all such rules and regulations are properly and efficiently enforced. The Referee is not responsible for the actual administration and conduct of the tournament except to enforce the rules and regulations. It is the Referee's duty to make such suggestions and recommendations as are necessary to enable the tournament staff to operate in the most satisfactory manner.

**20.10 NRA Official Jury** - At any Registered Tournament where no Referee is assigned or at any Approved Tournament, the Match Director shall appoint a Jury to be composed of persons who may or may not be competitors in the match, who are recognized as shooters and who are familiar with the NRA rules governing rifle matches. Tournament Officials may not serve as members of the Jury. This Jury shall act on any protest or dispute concerning procedures, equipment or any other question which may arise during the tournament.

## 21. NRA COMPETITION PROGRAMS

*Note: The program for tournaments must describe the conditions of the match, the positions, rifle, caliber of rifle, ammunition, target, ranges, and should cover all the following points:*

### TOURNAMENT NAME:

Do not designate State Championship unless authorized by the State Association; Sectional or Regional Championship unless authorized by the NRA.

### TOURNAMENT DATE(S):

Date or dates of tournament.

### SPONSORING ORGANIZATION:

Name of Club or Association

### FOR INFORMATION CONCERNING THE TOURNAMENT, WRITE TO:

Give name and complete address as you want listed in the *Coming Events* section of *Shooting Sports USA* notice.

### DIRECTIONS TO RANGE:

List directions clearly.

### RULES:

The statement that NRA Rules shall govern will allow the most liberal conditions found in those rules.

### COMPETITION OPEN TO:

Indicate eligibility requirements. See Rules 1.7(c) through 1.7(e). (Tournament sponsors may restrict competition to residents of certain areas; members of certain groups; competitors in certain classification groups; etc., provided such restriction is plainly stated in the program.)

**REGISTRATION FEE:**

List amount of tournament registration fee to be charged each competitor and what it entitles him to such as brassard, competitor number badge, etc., and a copy of the Official Bulletin.

**ENTRIES:**

List name and address of persons to whom entries should be mailed.

**ENTRY FEE:**

State amount per match (team and individual)

**ENTRIES CLOSE:**

State date and time.

**POST ENTRIES:**

Show that Post Entries will or will not be accepted, closing time and fee.

**ENTRY LIMIT:**

State number of entries that will be accepted.

**FIRING STARTS:**

State hour first relay of first match will begin each day.

**CLASSIFICATION OF COMPETITORS:**

See General Regulations. If NRA Classification System is not used or if classes are combined, list details.

**AWARDS:**

List schedule of awards for individual and team matches. Specify method, time and place of issuing awards.

**MATCH SCHEDULE AND CONDITIONS:**

Give complete details on course of fire, type of sights, rifle or, caliber of firearm, etc.

**GENERAL INFORMATION:**

List eating facilities, housing facilities, etc.

## 22. LIGHT RIFLE RULES

*Note: These rules are provided for the conduct of light rifle competition. Scores fired in this competition will be used for classification.*

*In all cases where specific rules are not given here, the appropriate rules for smallbore rifle competition shall be used.*

*In light rifle competition, the goal is to achieve the highest possible score within the confines of the allowed equipment.*

**3.3 Light Rifle** - Any rifle chambered for .22 caliber rimfire rifle cartridges only, a trigger pull of not less than two (2) pounds and weighs not more than eight and one-half (8 ½) pounds complete with sights, standard safety features and accessories. An adjustable

butt plate placed in the center position may be used and adjustable or custom butt plates shall not extend beyond the top or bottom of the stock and shall not exceed a maximum length of six (6) inches. Barrel weights must evenly surround the barrel and not hang below. Slings (Rule 3.13), palm rests (Rule 3.14), Schuetzen type butt plates (Rule 3.15), and electric or adjustable fore-end bedding devices are not permitted. Any sights (Rule 3.7(c)) will be used as long as total weight of rifle and sights does not exceed eight and one-half (8 ½) pounds. An eye shield may be attached to the rear sight.

The same rifle must be used throughout all stages of any one match except in case of a disabled rifle (Rule 9.5) or malfunction (Rule 9.6). The competitor may change rifles with the permission of the Chief Range Officer.

*Note: Tournament sponsors are authorized to restrict competitors to the use of only bolt action rifles if required by range regulations.*

**3.12 Clothing** - Padding is permitted on the shoulders and elbows of the shooting coat provided no padding extends below four (4) inches from the elbow joint. The coat may be to a maximum of hip-length with no straps or other provisions for tightening, or constructed with any material intended to make the shoulders or other parts more rigid. Shoes shall be a matched pair and may not be designed or altered in any way so as to provide artificial support.

**3.13 Slings** - A basic military sling or carry sling not to exceed 1 ¼" width may be used in connection with the rifle and one arm in the prone and kneeling position.

**4. Targets** - NRA Official Targets will be used.

50 Feet A-32 - Two (2) shots may be fired on each record bullseye.

50 Yard A-31 - Five (5) shots may be fired on each record bullseye.

Backing cards shall be used in NRA Registered Competition.

**5.14 Positions Authorized for Light Rifle Competition** - Prone (Rule 5.6), Kneeling (Rule 5.10) and Standing (Rule 5.12). Note: Tournament sponsors may elect to delete the last sentence in Rule 5.12 and require that the forward hand be extended so that the forward arm will be entirely free from touching or resting against the body. If this election is made it must be so stated in the tournament program.

### **7.7 Light Rifle Prone, Indoor and Outdoor Courses**

Distance	No. of Shots	Time
50 Ft or 50 Yd	20, 30, 60 or 120	1 Min. per record shot

Targets: NRA Official A-32 or A-31

Aggregates as desired by the Tournament Sponsor.

Team Matches: Teams may consist of 2 or 4 firing members with 20 or 40 shots to be fired by each member.

### 7.8 Light Rifle 3-Position, Indoor and Outdoor Courses

Distance	No. of Shots	Time
50 Ft or 50 Yd	30 (10 each position)	1 ½ Min. per record shot
50 Ft or 50 Yd	60 (20 each position)	1 ½ Min. per record shot
50 Ft or 50 Yd	120 (40 each position)	1 ½ Min. per record shot

Targets: NRA Official A-32, or A-31

Aggregates as desired by the Tournament Sponsor.

Team Matches: Teams may consist of 2 or 4 firing members with 30 shots (10 in each position) or sixty shots (20 in each position) to be fired by each team member.

### 7.9 Light Rifle Standing, Indoor and Outdoor Courses

Distance	No. of Shots	Time
50 Ft or 50 Yd	20, 30, 40, 60, 80, or 100	1 ½ Min. per record shot

Targets: NRA Official A-32, or A-31.

Aggregates as desired by the tournament sponsor.

Team Matches: Teams may consist of 2, 4, or 5 firing members with 20, 30, 40, 60, 80 or 100 shots to be fired by each member.

## 17. National Records May Be Established

(See Rule 17.5 (k), (l), (m))

### 19.4 Matches Used for Individual Classifications

(a) Light Rifle Prone Classification

Scores fired either indoor or outdoor, in any course of fire listed in Rule 7.7 or any combination of these courses.

(b) Light Rifle 3-Position Classification

Scores fired, either indoor or outdoor, in any course of fire listed in Rule 7.8. (Scores must include an equal number of shots in each position.)

(c) Light Rifle Standing Classification

Scores fired, either indoor or outdoor, in only Standing position.

### 19.6 Assigned Classification

(k) Light Rifle Prone

(l) Light Rifle 3-Position

## 19.15 Individual Class Averages

- (e) Light Rifle Prone (indoor and outdoor combined) - 90 shots minimum required for classification.

Master .....	98.00 and above
Expert.....	96.00 to 97.99
Sharpshooter .....	94.00 to 95.99
Marksman .....	Below 94.00

- (f) Light Rifle 3-Position (indoor and outdoor combined) - 120 shots minimum required for classification.

Master .....	94.00 and above
Expert.....	92.00 to 93.99
Sharpshooter .....	87.50 to 91.99
Marksman .....	Below 87.50

- (g) Light Rifle Standing (indoor and outdoor combined) - 120 shots minimum required for classification.

Master .....	94.00 and above
Expert.....	92.00 to 93.99
Sharpshooter .....	87.50 to 91.99
Marksman .....	Below 87.50

## 19.17 Reclassification

- (b)(4) Light Rifle - A competitor must have fired a minimum of 180 shots Prone, 200 shots Standing or 240 shots in 3-Position in NRA Approved or Registered competition to be eligible for an upward classification.

## • 23. F-CLASS SMALLBORE RIFLE RULES

*Note: These rules are provided for the conduct of F-Class smallbore rifle shooting events. Scores fired in this competition will be used for classification.*

*In all cases where specific rules are not given here, the appropriate rules for smallbore rifle competition shall be used.*

## 3. EQUIPMENT AND AMMUNITION

### 3.1.1 Smallbore F-Class Rifle

(a) **F-Class Open (F-O) Rifle** - A rifle restricted to fire .22 LR. "Rail guns" and positive mechanical methods of returning to the precise point of aim for the prior shot are not permitted. Any safe, manually operated trigger is permitted. Provisions of Rule 3.16 *Release Triggers* applies to this definition. Any sighting system is permitted, but it must be included in the rifle's overall weight.

(1) The rifle's overall weight, including all attachments such as sights and bipod, must not exceed 8.25 kilograms (approximately 18.18 pounds). An "attachment" also includes any external object, other than the competitor and apparel, which recoils or partially recoils with the rifle, or which is clamped, held, or joined in any way to the rifle for each shot, or which even slightly raises with the firing of the rifle from the rests.

(2) The width of the rifle's forend shall not exceed 76mm (approximately 3 inches).

(3) The rifle must be fired in the prone position from the shoulder of the competitor using rifle rests as defined in Rule 3.1.2(a).

**(b) F-Class Target Rifle (F-TR)** - A rifle restricted to fire .22 LR. The rifle must be fired off a bipod, rigidly attached to the rifle's forend, and/or a sling. Any bipod, meeting the definition of a bipod, may be used but its weight must be included in the rifle's overall weight. Any safe, manually operated trigger is permitted. Provisions of Rule 3.16 *Release Triggers* applies to this definition. Any sighting system is permitted, but it must be included in the rifle's overall weight.

(1) The rifle's overall weight, including all attachments such as sights, sling and bipod, must not exceed 8.25 kilograms (approximately 18.18 pounds). An "attachment" also includes any external object, other than the competitor and apparel, which recoils or partially recoils with the rifle, or which is clamped, held, or joined in any way to the rifle for each shot, or which even slightly raises with the lifting of the rifle from its rest/firing point.

(2) The rifle must be fired in the prone position from the shoulder of the competitor using rifle rests as defined in Rule 3.1.2(b).

### • 3.1.2 Smallbore F-Class Rifle Rests

**(a) F-Class Open Rifle (F-O)** - The F-Open rifle may be supported by a front rest bag, which may be fully adjustable for position but may not provide a positive mechanical method for returning the rifle to its prior point of aim from the previous shot. The rest may not mechanically capture the fore-end of the rifle in such a way that does not allow the rifle to be lifted directly up from the rest or to be placed directly down into the rest. Any rest which captures the fore-end of the rifle and that will not allow for the rifle to be lifted directly up from the rest shall be considered to be an attachment. The area of contact between the front bag and the rifle's fore-end will not exceed 76mm x 76mm (2.99 inches x 2.99 inches). The F-Open front rest may be employed for either the rifle's fore-end or for the shooter's forward hand. If attached, clamped or held onto the rifle in any way, a front rest must be included in the rifle's overall weight. The front rest may have up to three "feet". Each "foot" may terminate in a spike, which may be pressed into the ground by up to 50mm (about 2"), provided this causes no significant permanent harm or damage to the firing point.

(1) No more than two rests may be used. If two rests are employed, they may not be attached to each other.

(2) The use of any form of a table is prohibited. Separate flat boards or plates not exceeding the dimensions of 24"w x 12"d x 1/2"t are allowed to be placed under the front and no larger than 2" greater than the rear rests. See Rule 3.1.1(a)(1).

No leveling screws or protrusions are allowed on these boards or plates. They must be flat on the top and bottom.

*Note: This discipline is a modification of high power prone shooting, not a form of bench rest and should not be construed as such.*

*Note: Disabled competitors may apply to the NRA Protest Committee for appropriate dispensation.*

*Note: The intent of this rule is to prevent the use of a table type device.*

(3) A front rest may be employed for either the rifle's forend or for the forward hand. If attached, clamped, or held to the rifle, the front rest must be included in the rifle's overall weight [Rule 3.1.1(a)]



(4) No portion of the rifle's butt or pistol grip shall rest directly on the ground or on any hard surface. Furthermore, any rear rest employed shall not be attached, clamped, or held onto the rifle in any manner. Mechanically adjustable rear rests are not allowed.

(5) As an alternative to (3) or (4), the rifle may be rested on a simple central support such as a rolled jacket, towel, blanket, or groundsheet, or upon a sandbag or beanbag.

(6) Any number and type of objects may be placed beneath each rest to compensate for variations in the height of the slope of the firing point or to reduce its rolling.

(7) The front rest or base may have up to three spiked feet which may be pressed into the ground by no more than 50mm (approximately 2 inches) provided this causes no significant harm to the firing point.

(8) Rests may be adjusted after any shot to compensate for rest movement or settling. A sling may be used in conjunction with the rest(s), but its weight will be included in the rifle's overall weight [Rule 3.1.1(a)].

**(b) F-Class Target Rifle Rests-** A bipod and/or sling are the only allowed front supports for the F-TR rifle. The rifle may be supported by a bipod and/or sling and a rear support, which provide no positive mechanical method for returning it to its precise point of aim for the prior shot. Subject to:

1) The bipod and/or sling and rear support may not be attached to each other.

2) The use of any form of a table is prohibited. Separate flat boards or plates not exceeding the dimensions of 24" w x 12" d x 1/2" are allowed to be placed under the front rest and no larger than 2" more than the rear rest. No leveling screws or protrusions are allowed on these boards or plates. They must be flat on the top and bottom.

*Note: This discipline is a modification of smallbore prone shooting, not a form of bench rest and should not be construed as such.*

*Note: Disabled competitors may apply to the NRA Protest Committee for appropriate dispensation.*

*Note: The intent of this rule is to prevent the use of a table type device.*

3) A bipod is a device with no more than two legs that touch the firing point. It must be rigidly attached to the forend of the rifle. The bipod may have rigid or folding legs, and may be adjustable to compensate for the uneven surface of the firing point.

4) No portion of the rifle's butt or forend shall rest directly on the ground or any hard surface. A rear rabbit eared bag, small sandbag or a gloved hand may be used to support the rifle's butt. Any rear support may not be fixed to or protrude into the firing point. Mechanically adjustable rear support is not allowed.

5) Any number or type of objects may be placed beneath the bipod or rear support, to compensate for variations in height or slope of the firing point.

6) The bipod and rear rest may be adjusted after any shot to compensate for rest movement or settling. A sling may be used in conjunction with the rest(s), but its weight will be included in the rifle's overall weight [Rule 3.1.1 (1)]

**3.7 Sights-** Any sighting system is permitted, but it must be included in the rifle's overall weight.

## 4. TARGETS

*Note: When competitors mark targets for identification, they must be marked in bold letters "F-Class." (Stickers are recommended if practicable) For conventional and metric prone matches when shooting alongside target rifles, targets A-50/A-51, and A-33 are recommended. See Rule 19.4 below.*

### • 4.16 F-class Mini-palma 100 Yard Targets

100 Yard Target. F-37 - 4 bullseyes. LR (800 yds) target reduced to 100 yards. For use in Prone competition only. 5 through X rings black.

X-ring ..... 0.50" inches	7 ring ..... 3.90 inches
10 ring ..... 1.00" inches	6 ring ..... 4.90 inches
9 ring ..... 2.00" inches	5 ring ..... 5.80 inches
8 ring ..... 2.90 inches	4 ring ..... 6.80 inches

100 Yard Target. F-38 - 4 bullseyes. LR (900 yds) target reduced to 100 yards. For use in Prone competition only. 5 through X rings black.

X-ring ..... 0.45" inches	7 ring ..... 3.40 inches
10 ring ..... 0.90" inches	6 ring ..... 4.30 inches
9 ring ..... 1.80" inches	5 ring ..... 5.10 inches
8 ring ..... 2.60 inches	4 ring ..... 6.00 inches

100 Yard Target. F-39 - 4 bullseyes. LR (1000 yds) target reduced to 100 yards. For use in Prone competition only. 5 through X rings black.

X-ring ..... 0.40" inches	7 ring ..... 3.10 inches
10 ring ..... 0.80" inches	6 ring ..... 3.80 inches
9 ring ..... 1.60" inches	5 ring ..... 4.60 inches
8 ring ..... 2.30 inches	4 ring ..... 5.40 inches

## 5. POSITION

**5.6.1 Prone-** F-Class is fired in the prone position. The rifle may be supported with a bipod and/or sling and rear rest. See Rule 3.1.2.

### • 7.9 F-class Mini Palma

<i>Distance</i>	<i>Target</i>	<i>Sighter</i>	<i>Per Bull</i>	<i>Sights</i>
100 Yards	Simulated 800 YD	F-37	Unlimited	5 record shots Any
100 Yards	Simulated 900 YD	F-38	Unlimited	5 record shots Any
100 Yards	Simulated 1000 YD	F-39	Unlimited	5 record shots Any

*15 shots per target/45 Shots per Match*

**• 17. NATIONAL RECORDS** - *Note: All new categories of records will have scores collected for one year from date of approval and only the high score for each record for the year will become the record holder. Subsequently higher scores for each record category will become the new record holder.*

## • 17.5 Course of Fire for Which National Records are Recognized

*Note: National Smallbore Rifle Records are maintained for scores fired with Any Sights over the following courses for Open, Civilian, Regular Service, Reserve components including National Guard, Women, Senior, Junior, Intermediate Junior, and Sub-Junior categories.*

### (a) Outdoor Conventional/Metric Prone Courses:

(1) 20 shots at 50 yards, A-51 target or 50 meters, A-50 target and 20 shots 100 yards, A-33 target (Metric Dewar Course)

(2) 40 shots at 50 yards, A-51 target or 40 shots at 50 meters, A-50 target

(2a) 60 shots at 50 yards, A-51 target or 60 shots at 50 meters, A-50 target

(3) 40 shots at 100 yards, A-33 target

(4) Aggregate of 1200 comprised of once over matches #1, #2, #3, any sights

(5) Aggregate of 1600 comprised of twice over the Dewar Course, (#1), once over the 50 yard/50 meter course, (#2), and once over the 100 yard course, (#3) any sights

(6) Aggregate of 2400, combination of twice over the 1200 course (#4) any sights

(7) Aggregate of 2400, combination of twice over the 1200 course, (#4), with any sights

(8) Aggregate of 3200, combination of twice over the 1600 course (#5) any sight

(9) Aggregate of 4800, combination of twice over the 2400 course (#7) any sights

(10) Aggregate of 6400, combination of twice over the 3200 course, (#8), any sights.

(11) 15 shots at 100 yards, F-37 target

(12) 15 shots at 100 yards, F-38 target

(13) 15 shots at 100 yards, F-39 target

(14) Aggregate of 450 of (12), (13) & (14)

### (b) Two or Four Man Teams, fired by each member:

(1) Dewar Course, 20 shots 50 yards, A-51 target, and 20 shots 100 yards, A-33 target

(2) 40 shots at 100 yards, A-33 target

(3) 40 shots at 50 meters, A-50 target

(c) (1) Outdoor Metric Prone Team Courses Two and Four Man Teams - The following course to be fired by each member:

450 Aggregate:

15 shots at 100 yards (17.5(g)(11))

15 shots at 100 yards (17.5(g)(12))

15 shots at 100 yards (17.5(g)(13))

## 19. CLASSIFICATION

• **19.4 Scores Used for Individual Classifications-** Scores to be used for classification and reclassification will be those fired in matches in NRA competition as defined in Rule 1.6 (except Postal Matches) over the following courses of fire and under the indicated conditions:

Outdoor F-Class Classification:

Dewar Course (50 yards or 50 meters and 100 yards) (A-50/A-51 and A-33 targets)

50 Yards or 50 meters (A-50/A-51 and A-26/A-27 targets)

100 Yards (A-33 target and F37, F-38, F-39) target)

**19.15 Individual F-Class Averages-** Competitors will be classified as follows and NRA classification cards issued accordingly.

**TABLE 3- INDIVIDUAL**

(a) Outdoor F-Class classification- 200 shots minimum required for classification.

Master	97.50 and above
Expert	95.00 to 97.49
Sharpshooter	92.50 to 94.99
Marksman	Below 92.50

## APPENDIX GENERAL REGULATIONS FOR NRA SANCTIONED TOURNAMENTS

*Tournament sponsors must follow these Regulations as directed by Rule 1.4. They provide standard procedures required for the sanctioning of NRA Tournaments, establishing of fee structures, awards, reporting, cancellation, NRA membership requirements, and other items involved with NRA Sanctioned Tournaments, both Registered and Approved.*

### A. GENERAL REGULATIONS GOVERNING NRA APPROVED TOURNAMENTS

**1. SANCTION OF NRA APPROVED TOURNAMENT(S):** To obtain approval of tournaments, the following steps must be taken by the sponsoring organization in advance of the tournament date.

- (a) Send NRA your completed applications and draft copies of your completed programs a minimum of **30 days** in advance of the tournament date.
- (b) If the above is not done, the NRA reserves the right to cancel its sanction of the tournament.
- (c) In order to be listed once in the *Coming Events* section of *Shooting Sports USA*, your applications and programs must be sanctioned by the Competitive Shooting Division by the 15th of the month, two months before the month of issue. If you desire publicity in more than one issue, an additional month's notice must be allowed for each monthly listing.

**2. GRANTING OF APPROVED SANCTION:** As soon as the tournament is granted Approved sanction, one copy of the signed application, an Official Sanction Poster, and a corrected (if necessary) copy of the draft program will be returned to the sponsor. These items provide the authority to the sponsor to conduct the tournament. All changes and information provided in the approved draft program must appear in the final printed program. No major changes in courses of fire, number of matches, etc., may be made unless NRA is notified. This may be done in writing if time permits, or by including a copy of the Match Director's Bulletin (which makes the changes) with the final results of the tournament.

**3. TOURNAMENT CANCELLATION:** If a tournament is canceled, NRA must be notified immediately.

**4. CLASSIFICATION OF COMPETITORS:** The NRA Classification System may be used, but is not required.

**5. COURSES OF FIRE IN APPROVED TOURNAMENTS, FOR CLASSIFICATION USE:** Courses of fire which may be used for classification are listed in Rule 19.4. It is not required that these specific courses of fire be used in Approved Tournaments, but, if the scores are to be used for classification, they must be used.

**6. AWARDS:** All awards are furnished by the sponsor. The minimum award schedule must include only the Tournament Winner, that person/team firing the highest score regardless of classification or category. The method, time, and place of issuance of awards is at the option of the sponsor with due notice to the competitors in the tournament program.

**7. ENTRY FEES:**

- (a) NRA Registration Fee: A fee of **\$4.50** per competitor is charged by NRA for Approved Tournaments.
- (b) Sponsor Entry Fees: The amount of these fees is determined by the Sponsor, and must be stated in the program separately from the NRA Registration Fee.

**8. TOURNAMENT OFFICIALS AS COMPETITORS:** Officials may compete in Approved Tournaments.

**9. NRA MEMBERSHIP:** NRA membership is not required for participation in NRA Approved Tournaments. However, sponsors may elect to restrict those persons entering the tournament to NRA members only, if they wish to do so.

**10. REPORTS TO NRA:** The Match Director is responsible for making certain that the following reports are forwarded to NRA within 30 days of firing. (See Rule 19.13)

- (a) An SR-1 (Conventional) card for each competitor showing the total number of shots fired in individual matches and a total score; the total number of shots fired in Fired Team Matches, and the total score in the fired team match(es). The NRA membership ID number, if applicable, must be indicated on each card for classified competitors and NRA members who are not yet classified. Score Reporting cards are available free of charge upon request in packs of 50.
- (b) A Registration Fee and Match Reporting Form and remittance of **\$4.50** per competitor.
- (c) A copy of any special Match Director's Bulletins.

## **B. GENERAL REGULATIONS GOVERNING NRA REGISTERED TOURNAMENTS**

The following regulations are established to provide standard procedures for all registered tournaments except Regional, Sectional and National Championships. State Championships MUST be approved and recognized by the State Association (Rule 1.6).

**1. SANCTION OF NRA REGISTERED TOURNAMENT(S):** To obtain approval of tournaments, the following steps must be taken by the sponsoring organization in advance of the tournament date.

- (a) Send NRA your completed applications and draft copies of your completed programs a minimum of 45 days in advance of tournament date.
- (b) If the above is not done, the NRA reserves the right to cancel its sanction of the tournament.
- (c) In order to be listed once in the *Coming Events* section of *Shooting Sports USA*, your applications and programs must be sanctioned by the Competitive Shooting Division by the 15th of the month, two months before the month of issue. If you desire publicity in more than one issue (up to a maximum of 6 months), an additional month's notice must be allowed for each monthly listing.

**2. GRANTING OF REGISTERED SANCTION:** As soon as a tournament is granted Registered sanction, one copy of the signed application, program, and Official Sanction Poster will be returned to the sponsor. These items provide the authority to the sponsor to conduct the tournament. In cases where a Referee is assigned, the Official Poster will be mailed after the Referee assignment is made, and the sponsor will be notified of the identity of the Referee at the same time. All changes and information provided in the approved draft program must appear in the final printed program. No major changes such as courses of fire, number of matches, etc., may be made unless NRA is notified. This may be done in writing if time permits, or by including a copy of the Match Director's Bulletin (which makes the changes) with the final results of the tournament.

## GLOSSARY

*Rifle shooting, like other sports, has its own "Language"- technical terms, slang and idioms. Many of the words and expressions used in these Official Regulations are defined as a part of the Rules. The following definitions (or more properly, explanations) are given for the benefit of the tyro to help him to a clear understanding of the Regulations:*

**Backer (Backing Target)** - A blank paper of target size and material positioned in accordance with Rule 6.7. Used to detect cross-fires, excess hits and to verify, when required, the number of record shots fired on the target.

**Bullseye** - An aiming point printed on a target card. The aiming point for shooting is usually circular and contains concentric numbered rings for scoring purposes.

**Category** - A grouping of individuals designated by a specific title in a tournament program to establish a system of competing for awards. Those groupings may be used within a classification, or in certain circumstances, instead of classification. (Examples: Junior, Senior, Military, Collegiate, etc.)

**Classification** - The grouping of individuals by averaging a number of match scores. Classifications are designed to have individuals compete for awards against others of similar competitive skill levels.

**Dewar Course** - This course of fire obtains its name from the International Dewar Team Match. The course consists of 20 shots at 50 yards and 20 shots at 100 yards from the prone position using either standard or metric targets. Metallic sights are used in the International Match. Domestic competition is also fired with telescopic sights.

**Entry** - The act of declaring intent to shoot in a match and the paying of the required fee to the proper official in accordance with the program for such match.

**Fouling Shots** - Shots fired for the purpose of clearing the bore of cleaning solution and to settle the barrel, preparatory to sighting and record shots.

**Framing Targets** - A term used to describe the act of placing smallbore targets on the frames ready for firing.

**Match** - A complete event as indicated in the program for the issuance of certain specific awards. A match may consist of one or of several stages. It may, in the case of aggregate matches, include the scores fired in several subsidiary matches.

**Post Entry** - An entry made after the regular entry closing time. Because of the extra work placed on the Statistical Office as a result of late entries, an additional fee is charged (the Post Entry Fee). Sometimes no post entries are accepted. Post Entries have no connection with Postal Matches.

**Postal Match** - A match in which competitors fire on their home ranges using targets which have been marked for proper identification. Fired targets and/or scores are then exchanged by mail.

**Ready Line** - A line that is behind and parallel to the firing line, in front of which only competitors, coaches (in team matches) and match officials may cross.

**Score** - The total value of all required shots fired by a competitor in any one match.

**Sighting Shots** - Shots fired at a target provided for that purpose and used to obtain desired information relative to adjustment of sights for the match which immediately follows.

**String** - A series of shots (usually 5 or 10 shots) forming a part of a stage. For example, on the 50 yard smallbore target the competitor fires 5-shot strings at each of 4 bullseyes to complete a 20 shot stage. On the 100 yard smallbore target the competitor fires 10-shot strings on each of 2 bullseyes to complete a 20 shot stage.

**Stage** - In a match fired at more than one range or in more than one position, each range or position is referred to as a stage of the match. The Dewar Match is a 2-stage match as it calls for 20 shots at 50 yards and 20 shots at 100 yards.

**Target** - A surface, usually paper or tagboard, containing one or more aiming points that is frequently called a target card.

**Target Butts** - It might be said that “target butt” (or target pit) is a general term referring broadly to that end of the range which receives the bullets as compared to the other end of the range, broadly referred to as the firing line, which sends the bullets. A more specific application of target butts is applied to the parapet which protects the target markers and over which the targets are exposed for firing.

**X-Ring** - An inner circle placed inside the bullseye of many targets. This inner circle makes it possible to decide tie scores without changing the total score. The highest value for a hit on a smallbore target is 10. Consequently the inner circle placed in these targets is designated an X (the Roman numeral ten).



## NRA DISTINGUISHED SMALLBORE RIFLEMAN AWARDS

The National Rifle Association inaugurated a plan in 1965 whereby tournament shooters may earn an award in smallbore rifle competition similar to the Distinguished awards that have been available for years to Service rifle and Service pistol shooters.

The NRA Distinguished Smallbore Rifleman Award can be earned only by participating in Open Regionals and National Championships (outdoor and indoor).

The following general conditions have been approved by the NRA Executive Committee to govern the earning of these awards.

- **Type of Designation:** One NRA Distinguished Smallbore Rifleman Award will be issued for all-prone shooting and one for F-SBR. Another will be issued for position shooting. Required “steps” must be earned for each type. A shooter may be presented both awards after earning the required steps.

In 2009, the Double Distinguished Smallbore Rifleman Award was first awarded, recognizing those shooters who had earned both the Position and Prone Rifleman Awards.

**The Award:** A specially designed medallion, brassard, and lapel pin will be awarded to each individual who successfully completes the requirements for the Distinguished Award. For those shooters who earn both the Position and Prone Rifleman Awards, a specially designed lapel pin will be awarded.

**Steps:** Each individual NRA member who attains a place in the top-scoring 10% of the competitors in each of the designated tournaments in which he participates will have earned a step toward an NRA Distinguished Smallbore Rifleman Award. Designated tournaments are those specified above. Each shooter who makes the same numerical score (X's are not part of the numerical score) as the last score in the high 10% will be awarded a step toward Distinguished.

**Award of NRA Distinguished Smallbore Rifleman:** A shooter who earns a minimum of 4 steps will be presented an NRA Distinguished Smallbore Rifleman Award under the following provisions:

- (a) At least one step must be earned for competition in the NRA National Outdoor Championship.
- (b) A maximum of 2 steps for each type of this Distinguished Award may be earned for official credit by a shooter during any one calendar year.
- (c) The earnings of each step will be recognized by the issuing of an appropriate certificate. A certificate will be issued for each step a shooter may earn even though a step may be in excess of those used for official credit during a single calendar year. No step certificates will be issued after a shooter has become distinguished.

## **NRA HONORARY CLUBS**

The NRA offers special recognition for smallbore rifle shooters who have fired outstanding scores in competition by admitting them to the NRA Honorary Clubs listed below. Membership is acquired by either equaling or surpassing predetermined scores in NRA Sanctioned tournaments.

It is the responsibility of the competitor or the tournament sponsor to notify the NRA Competitions Division of possible new Honorary Club members. The information must include complete name and address of the individual, the score, and a copy of the Official Bulletin in which that score was fired. Honorary Club mementos for 400, 570, 800, 1600 & 3200 Clubs are available.

### **The 400 Club**

The 400 Club was organized at Camp Perry in 1933 with 12 charter members. For membership, a competitor had to fire a score of 400 over the Dewar Course with metallic sights in individual match competition during the National Matches. In 1951, the Club rules were extended to include such scores from Smallbore Rifle Regionals.

### **The 570 Club**

The 570 Club is for NRA Junior Shooters equaling or surpassing 570 in NRA Registered NRA Metric Position Smallbore Rifle Tournaments. This Honorary Club was started on January 1, 1976.

### **The 800 Club**

The 800 Club is open to any individual who fires a score of 800x800 in individual fired Prone, Sitting, Kneeling and Standing matches in NRA indoor Smallbore Rifle Registered competition, as specified in an aggregate in the tournament program.

### **The 1600 Club**

The 1600 Club is open to any individual who fires a score of 1600x1600 with either metallic, any or a combination of sights in an NRA outdoor Smallbore Rifle Prone Registered tournament.

### **The 3200 Club**

The 3200 Club is open to any individual who fires a score of 3200x3200 in two 1600-point aggregates (50 meters, 50 yds., Dewar and 100 yds.) from individual matches fired in NRA Registered Smallbore Rifle Prone competition, as specified in an aggregate in the tournament program.

# WINCHESTER/NRA MARKSMANSHIP QUALIFICATION PROGRAM

Shooters always like some means by which they can measure their ability and progress. Whether the shooting is done at home, at the club range or in a tournament, there is greater satisfaction in achieving a previously set goal than just practicing. There are qualification courses for many types of shooting with fine awards within the reach of every shooter.

For specific information, direct your questions to the NRA Education and Training Division, 11250 Waples Mill Road, Fairfax, Virginia 22030.

## AWARDS SCHEDULES

### Combining Classes

Most tournament programs contain a Schedule of Awards, which usually includes awards for class and category with minimum entry requirements. When fewer than the stated minimum in a class/category have entered, it is necessary to combine classes of different categories. The following is a suggested system for use in the tournament programs. Categories may be added or deleted as required.

When there are less than (No.) competitors, or (No.) teams within a class they will be combined within the class as follows until a total of \_\_\_ or more individuals or \_\_\_ or more teams is obtained by combining as indicated by the arrows.

- A Junior.....  Civilian.....  Service
- B Civilian.....  Junior.....  Service
- C Service.....  Civilian.....  Junior

# INDEX

<i>Item</i>	<i>Rule</i>
Actions Open .....	10.1.1
Aggregate Match .....	1.7
Aliases .....	9.23
Altered Targets, Scoring .....	14.11
Alternates, Substitution .....	12.4
Ammunition .....	3.17
Any Position .....	5.13
Any Rifle .....	3.2
Approved Tournaments .....	1.6 & Page iii
General Regulations .....	1.4
Programs .....	21
Refusal of .....	1.5
Rules .....	1.3
Artificial Illumination .....	6.5
Support .....	5.2
Assigned Classification .....	19.6
Assignment of Tournaments, Referee's .....	20.7
Authorization .....	1.2
Refusal or Withdrawal of .....	1.5
Authorized NRA Events .....	1.2
Rules 1.3	
Averages, Individual Classification .....	19.15
Awards, Schedules .....	Appendix
Backing Targets .....	6.7
Breaking Ties .....	15
League .....	15.11
Re-Entry Match .....	15.10
Team Matches .....	15.8
Unbreakable .....	15.17
Bribery .....	9.26
Bulletin Board, Checking .....	18.13
Bulletin, Official .....	11.6.4
Changing .....	11.6.6
Correction of Errors .....	11.6.5
Match Director's .....	11.1, 18.13
Preliminary .....	11.6.3
Bullseyes, Numbering of .....	15.2
Butt Plate and Hook .....	3.15
Cards, Range Assignment .....	11.6.10
Cartridge, Defective .....	9.4
Cease Firing .....	10.1.4, 18.10
Center Shots .....	14.3
Challenge .....	16.1, 20.6
Fee .....	16.1
Team Matches .....	16.4
Changing Rifles .....	9.1
Civilian .....	2.2
Club Team .....	2.15
Classification .....	19
Appeals .....	19.10
Assigned .....	19.6
Averages, Scores used for .....	19.5
Changing in a Tournament .....	19.7
Combining .....	19.8.1, Appendix
Competitors .....	18.4, 19.1
Competing in Higher Class .....	19.8
Establishing Indoor .....	19.16
Classification	
Establishing Outdoor Position .....	19.16
Establishing Outdoor Prone .....	19.16
Falsification .....	9.24
Individual Averages, Indoor .....	19.15
Individual Averages, Outdoor Position .....	19.15
Individual Averages, Outdoor Prone .....	19.15
Lack of Evidence .....	19.7
Lifetime Master .....	19.21
Matches Used for .....	19.4

<i>Item</i>	<i>Rule</i>
Obsolete	19.9
Protest	19.11
Reclassification	19.17
Reporting Scores	19.13
Score Record Book	19.14
Team	19.12
Temporary	19.14
Clothing	3
Coaching, Individual Matches	9.10
Team Matches	12.6
College Competitors	2.8
Teams	2.16
Commands, Firing Line	10.7
Repeating	10.6
Competition, Types	1
League	1.6
NRA	1
Programs	21
Competitor	
Civilian	2.2
Classification	18.4
Classified	19.1
College	2.8
Discipline	10.1
Disqualification	9.30
Duty to	11.9
Eligibility	18.3
Individual Entries	18.5
Junior	2.3
Knowledge of Program	18.2
National Guard	2.5
Physically Disabled	13
Police	2.4
Position	9.9
Regular Service	2.6
Reserve	2.7
Residence	2.20
Responsibility	18.15
School	2.9
Senior	2.2.1
Suspension	9.31
Unclassified	19.2
Will Score	10.5
Conduct, Disorderly	9.27
Continuation of Fire	9.7
Courses of Fire	7
For National Records	17.5
Cross-Fire and Excessive Hits	9.25
Cuffs, Sling	3.13
Defective Cartridge	9.4
Procedure	10.9
Disabled Competitor, Physically	13
Disabled Rifle	9.5
Discipline	10.1, 18.1
Disqualification	9.30
Distance, Firing	6.4
Distinguished Rifleman Awards	Appendix
Ear Protection	3.20
Early or Late Shots	9.30, 14.5
Elbow Pads	3.12
Electronic Scoring Targets	10.10
Eligibility, Competitor	18.3
Referee	20.1
Entries, Individual	18.5
Empty Chamber Indicator (ECI)	3.21
Equipment	3, 3.18
Excessive Shots	14.7

<i>Item</i>	<i>Rule</i>
Eye Protection . . . . .	3.19
Firing, Continue to . . . . .	9.7
Courses of . . . . .	7.1
Firing Line . . . . .	6.1
Commands . . . . .	10.7
Firing Point . . . . .	6.2
Clearing . . . . .	18.12
Reporting At . . . . .	18.7
Shelter . . . . .	6.3
Flags, Wind . . . . .	6.9
Fouling Shots . . . . .	9.2
Gauges, Scoring . . . . .	14.3
General Equipment . . . . .	3.18
General Regulations for NRA Sanctioned Tournaments . . . . .	Appendix A&B
General Regulations . . . . .	1.4
Glossary . . . . .	Appendix
Gloves . . . . .	3.11
Ground Cloth . . . . .	3.10
Ground, The . . . . .	5.1
Hanging Targets, Competitors . . . . .	10.1.9, 18.15 (e)
Hits, Non Visible . . . . .	14.9
Hits on Wrong Target . . . . .	14.10
How to Challenge . . . . .	16.1
Illumination . . . . .	6.5
Individual	
Civilian . . . . .	2.2
Classification Averages . . . . .	19.15
Classification, Matches used for . . . . .	19.4
College . . . . .	2.8
Duties and Responsibilities . . . . .	18
Entries . . . . .	18.5
Establishing Classification . . . . .	19.16
Intermediate Junior . . . . .	2.3.1
Junior . . . . .	2.3
Match Coaching . . . . .	9.10
National Guard . . . . .	2.5
National Record, Scores for . . . . .	17.3
Police Competitors . . . . .	2.4
Reclassification . . . . .	19.17
Regular Service . . . . .	2.6
Individual	
Reserve . . . . .	2.7
School . . . . .	2.9
Squadded Matches . . . . .	1.7
Squadding . . . . .	11.6.7
Sub-Junior . . . . .	2.3.2
Substitution of Alternates . . . . .	12.4
Unsquadded Match . . . . .	1.7
Indoor Classification . . . . .	19.15
Averages . . . . .	19.15
Reclassification . . . . .	19.17
Interference . . . . .	9.13
Intermediate Junior . . . . .	2.3.1
International Matches . . . . .	1.6
Invitational Match . . . . .	1.7
Junior, Club Teams . . . . .	2.18
Competitors . . . . .	2.3
Intermediate . . . . .	2.3.1
Rifle . . . . .	3.4
Sub-Junior . . . . .	2.3.2
Jury . . . . .	11.2.1, 20.10
Kits, Shooting . . . . .	3.9
Kneeling	
Position . . . . .	5.10
Roll . . . . .	3.14.1
Knowledge of Program . . . . .	18.2

<i>Item</i>	<i>Rule</i>
Lack of Classification Evidence . . . . .	19.7
Late Shots Scored . . . . .	14.5
League, Sanctioned . . . . .	1.6
League Ties, Breaking . . . . .	15.11
Light Rifle Rules . . . . .	22
Loading . . . . .	18.9
Loud Language . . . . .	10.2
Malfunction . . . . .	9.6
Procedure . . . . .	10.9
Match . . . . .	15.1
Aggregate . . . . .	1.7
Classified . . . . .	1.7
Courses . . . . .	7
Delaying A . . . . .	9.30(g), 10.3
Deputy Match Director . . . . .	11.1.1
Director . . . . .	11.1
Individual Entries . . . . .	18.5
National Championship . . . . .	1.6
NRA Sanctioned . . . . .	1.1
Not Complete (Individual/Team) . . . . .	9.11
Open . . . . .	1.7
Postal . . . . .	1.6
Re-Entry . . . . .	1.7
Regional . . . . .	1.6
Registered . . . . .	1.6
Restricted . . . . .	1.7
Sectional . . . . .	1.6
Squadding Tickets . . . . .	18.6
State Championship . . . . .	1.6
Team, Squadded . . . . .	1.7
Squadding . . . . .	11.6.8
Unsquadded . . . . .	1.7
Members, NRA . . . . .	2.1
Non-U.S. Citizen . . . . .	2.1.1
Metallic Sights . . . . .	3.7
Misplaced Shots . . . . .	14.7
Misplaced Sighting Shots . . . . .	9.2.1
Misses Scored . . . . .	14.4
Multiple Stage Matches, Checking Targets in . . . . .	10.1.8
National Championship Matches . . . . .	1.6
National Championship Protest Committee . . . . .	11.8
National Guard Competitors . . . . .	2.5
Teams . . . . .	2.13
National, Individual Record Scores . . . . .	17.3
National Matches . . . . .	1.6
National Records . . . . .	17
Co-Holder . . . . .	17.6
Continue to Fire for . . . . .	9.7
Course of Fire for . . . . .	17.5
Scores Used . . . . .	17.2
Team Records . . . . .	17.4
Where Fired . . . . .	17.1
Not Ready . . . . .	10.1.5
Numbering of Bulleyes . . . . .	15.2
Offhand Position . . . . .	5.12
Officials, Tournament . . . . .	
Chief Range . . . . .	11.4.1
Director, Deputy Match . . . . .	11.1.1
Director, Match . . . . .	11.1
Director, Range . . . . .	11.4
Range Officer . . . . .	11.5
Statistical Officer . . . . .	11.6
Target and Pit Officers . . . . .	11.7
Outdoor Classification . . . . .	19.15
Averages . . . . .	19.15
Position . . . . .	19.15
Prone . . . . .	19.15

<i>Item</i>	<i>Rule</i>
Reclassification	19.17
Padding	3.12
Palm Rests	3.14
Passage of Time	8.4
Penalties/Disqualifications	9.30
Police Competitors	2.4
Police Teams	2.14
Position of Rifle Butt	5.3
Positions	5
Any	5.13
Competitor's	9.9
Illegal	5.14
Positions	
Team Captain	12.5
Team Coach	12.5
Postal Matches	1.6
Preliminary Bulletin	11.6.3
Preparation Period	10.3.1
Programs	21
Change to	11.1, 18.13
Knowledge of	18.2
Prone Position	5.6
Protests	16.2, 20.6
How to	16.3
Team Matches	16.4
Public Affairs	2
Range, Policing	10.4
Range Standards	6
Reclassification, Indoor	19.17
NRA Metric Position	19.17
NRA Metric Prone	19.17
Outdoor Position	19.17
Outdoor Prone	19.17
Records, Retention of	11.6.2
Re-Entry Match	1.7
Referee, NRA Official	20, 11.2
As Competitor	20.8
Assigned to Tournaments	20.7
Certification	20.2
Duties, General	20.3
Before Tournament	20.4
During Tournament	20.5
Eligibility	20.1
Handling Challenges and Protests	20.6
Status	20.9
Refires	10.9, 9.14
Refusal to Obey	9.28
Regional Matches	1.6
Registered	
Matches	1.6
Tournaments	1.1 and Page iii
General Regulations	1.4
Programs	21
Refusal	1.5
Registered Tournaments	
Rules	1.3
Regular Service Competitors	2.6
Team	2.13
Regulations, General, NRA Events	1.4
Release Triggers	3.16
Reporting at Firing Point	18.7
Reserve, Competitor	2.7
Teams	2.13
Residence, Competitor's	2.20
Responsibility, Competitor's	18.15
Rest, Palm	3.14
Restricted Match	1.7



<i>Item</i>	<i>Rule</i>
Ricochets	14.8
Rifle	
Any	3.2
Changing	9.1
Disabled	9.5
Junior	3.4
Loaded	10.1.3
The Rifle	3.1
Unloaded	10.1.2
Rifle Butt, Position of	5.3
Item Rule	
Roll, Kneeling	3.14.1
Rules, Evasion of	9.29
NRA Events	1.3
Sanctioned Leagues	1.6
School, Competitors	2.9
Teams	2.17
Score	14
Cards	
Must be Signed	18.14
Targets Are	14.2.1
Checking	18.11
Classification, Average	19.5, 19.15
Competitors Will Score	10.5
Falsification	9.24
Gauges	14.3
National Records	17.1, 17.2, 17.3, 17.4
Scoring	
Altered Targets	14.11
Scoring	
Center Shots	14.3
Devices	14.3
Early Shots	14.5
Electronic Scoring	10.10
Excessive Hits	14.7
Gauges, Authorized Use of Plug	14.3.1
Hits on Wrong Bullseye	14.10
Hits on Wrong Target	14.10
How to	14.3
Incorrect Targets	14.12
Late Shots	14.5
Misses	14.4
Non-visible Hits	14.9
Ricochets	14.8
Ties, Decision of	15
Visible Hits and Close Groups	14.9
When to	14.1
Where to	14.2
X's	14.3
Sectional Matches	1.6 (d)
Senior Competitors	2.2.1
Shelter, Firing Line	6.3
Shoes	3.11.1 (c)
Shooting Coats	3.11.1
Shooting Kits	3.9
Shooting Mats	3.10
Shooting Trousers	3.11.2
Shots	
Fouling and Sighting	9.2
Misplaced Sighting	9.2.1
Sights	3.7
Any	3.7(c)
Metallic	3.7(a)
Corrective	3.7(a)
Non-corrective	3.7(a)
Single Loading	10.1.6
Sitting Position	5.8

<i>Item</i>	<i>Rule</i>
Slings	
Cuffs . . . . .	3.13
Pads . . . . .	3.13
Spotting Scopes . . . . .	3.8
Squadded	
Individual Match . . . . .	1.7 (g)
Team Match. . . . .	1.7 (j)
Squadding	
Individual . . . . .	11.6.7
Team . . . . .	11.6.8
Tickets. . . . .	18.6
Stage . . . . .	1.7
Standing Position . . . . .	5.12
State, Association Teams . . . . .	2.12
Championships . . . . .	1.6
Statistical Office Duties. . . . .	11.6.1
Status of Referee . . . . .	20.9
Stock Changing . . . . .	9.1
Sub-Junior . . . . .	2.3.2
Support, Artificial . . . . .	5.2
Suspension . . . . .	9.31
Targets . . . . .	4
As Score Cards . . . . .	14.2.1
Backing . . . . .	6.7
Targets	
Card. . . . .	14.7
Carriers, Ranges With . . . . .	10.1.9
Checking in Multiple Stage Matches. . . . .	10.1.8
Dimensions . . . . .	4
Electronic Scoring . . . . .	10.10
Height . . . . .	6.8
Illumination . . . . .	6.5
Interference. . . . .	9.13
Numbers . . . . .	6.6
Officers . . . . .	11
Official . . . . .	4.1
Teams	
Affiliated Club . . . . .	2.11
Captain . . . . .	12.1
Captain's Position . . . . .	12.5
Checking Scores . . . . .	12.7
Civilian Club . . . . .	2.15
Classification . . . . .	19.12
Coach. . . . .	12.2
Coaching . . . . .	12.6
Coach's Position . . . . .	12.5
College Club . . . . .	2.16
Entries. . . . .	12.3
Junior Club . . . . .	2.18
Match Challenges . . . . .	16.4
Match, Checking Scores In . . . . .	12.7
Match, Coaching in . . . . .	12.6
Match Protests . . . . .	16.4
National Guard . . . . .	2.13
National Records . . . . .	17.4
Pickup . . . . .	2.10
Police . . . . .	2.14
Regular Service . . . . .	2.13
Representation . . . . .	2.10
Reserve . . . . .	2.13
School . . . . .	2.17
Squadded Match . . . . .	1.7 (j)
State Association . . . . .	2.12
Substitute of Alternates . . . . .	12.4
Time . . . . .	8.3
Time, Passage of . . . . .	8.4
Unsquadded Match. . . . .	1.7

<i>Item</i>	<i>Rule</i>
Telescopic Sights .....	3.7
Temporary Classification .....	19.14
Tickets, Squadding .....	18.6
Ties	
Decision of Ties .....	15
Center Shots .....	14.3
Center Shots of Higher Value .....	14.3
Continue to Fire to Break .....	9.7
League .....	15.11
Matches Which Include	
Both Rifle and Pistol .....	15.9
Match .....	15.1
Numbering of Bulleyes .....	15.2
Re-Entry Matches .....	15.10
Tie Breaking for All Matches .....	15.7
Team Matches .....	15.8
Ties for Selection of U.S. Team .....	15.12
X-Ring Shots of Higher Value .....	14.3
Time	
Allowance .....	8.2
Computing .....	8.1
Passage of .....	8.4
Team .....	8.3
Timing .....	18.8
Tournament	
Approved .....	1.6
Chief Range Officer .....	11.4
Match Director .....	11.1
Officials .....	11
Range Officer .....	11.5
Referee .....	20
Registered .....	1.6
Statistical Officer .....	11.6
Target Officer .....	11.7
Trigger, Release .....	3.16
Unclassified Competitor .....	19.2
Unloaded Rifle .....	10.1.2
Unsquadded	
Individual Match .....	1.7 (h)
Unsquadded	
Team Match .....	1.7 (k)
Weighing Triggers .....	9.8
Withdrawal of NRA Authorizations .....	1.5
X-Ring .....	14.3
Wind Indicators, Personal .....	3.9.1

More information concerning competition materials  
 and supplies can be obtained from  
 NRA Sales at 1-800-336-7402,  
 Monday through Friday from 9:00 a.m. to 9:00 p.m. EST

## NOTES

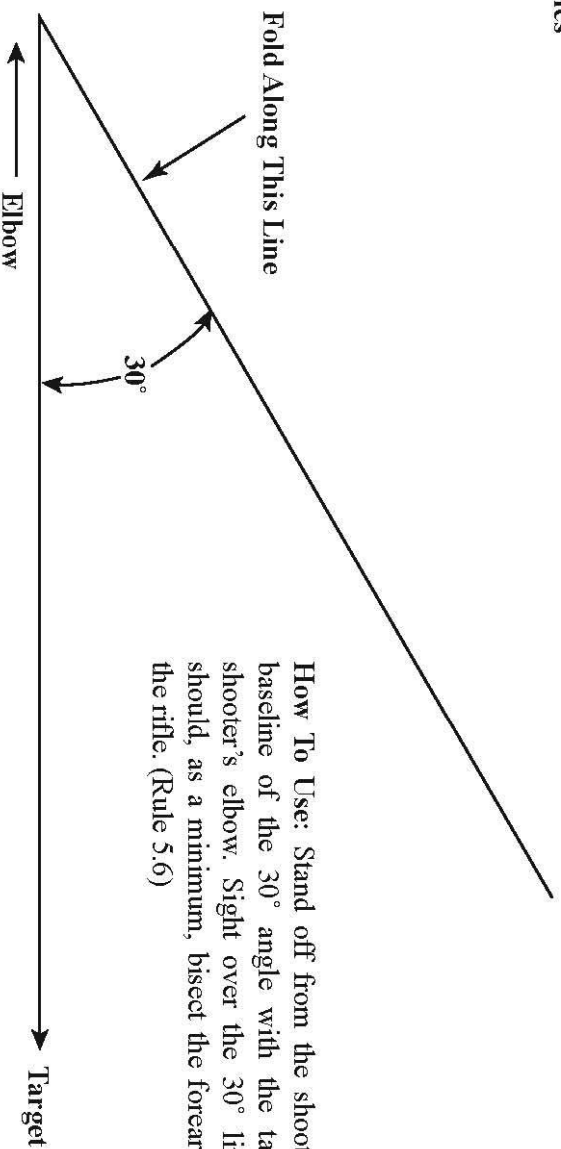
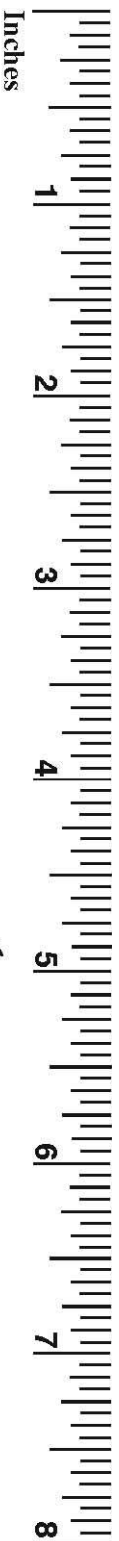

**How To Use:** Stand off from the shooter. Align the baseline of the 30° angle with the target and the shooter's elbow. Sight over the 30° line. This line should, as a minimum, bisect the forearm supporting the rifle. (Rule 5.6)

# The best resource for competitive shooters.

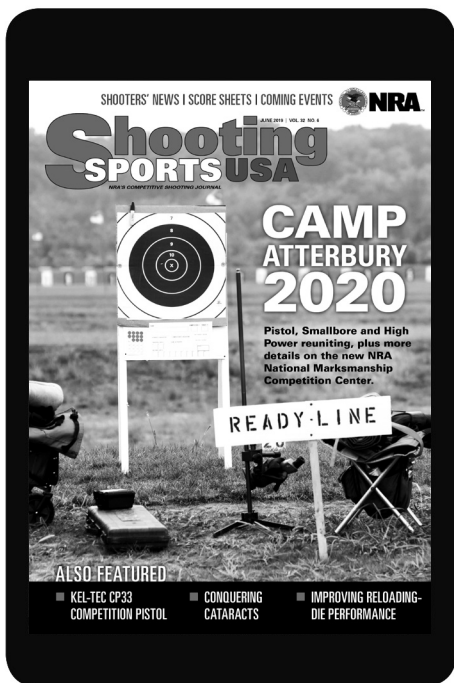

HOW-TO ARTICLES  
FIREARM REVIEWS  
MATCH SCHEDULES

TOURNAMENT REPORTS, SCORES AND PHOTOS  
COVERAGE FROM NATIONAL CHAMPIONSHIPS

**Did we forget to say it's a  
free monthly online magazine?  
Sign up for *Shooting Sports USA* today.**

**SSUSA.ORG**

NO OBLIGATION. CANCEL AT ANY TIME.